

DOUBLEFEATURE™



Omnivision **VHS**

Panasonic®

**DVD/VCR DECK
Operating Instructions
Model No. PV-D4734S**

**Initial Setup
(Connection)**

**Basic
Operation**

**VCR
Operation**

**DVD
Operation**

**For Your
Information**



Connections and Initial Setup Procedures are on pages 12 to 17.



MULTI FORMAT PLAYBACK



*Ability to play back may depend on recording conditions.



As an **ENERGY STAR®** Partner, Matsushita Electric Corporation of America has determined that this product or product model meets the **ENERGY STAR®** guidelines for energy efficiency.

Please read these instructions carefully before attempting to connect, operate or adjust this product. Please save this manual. Spanish Quick Use Guide is included. (Guía para rápida consulta en español está incluida.)

For assistance, please call : 1-800-211-PANA(7262) or, contact us via the web at:<http://www.panasonic.com/contactinfo>

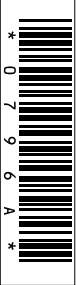

Important Safeguards and Precautions

⚠ WARNING

TO REDUCE THE RISK OF ELECTRIC SHOCK, FIRE, INJURY TO PERSONS OR DAMAGE TO THIS PRODUCT, READ AND RETAIN ALL SAFETY AND OPERATING INSTRUCTIONS. HEED ALL WARNINGS IN THE MANUAL AND ON THE PRODUCT.

INSTALLATION

1 POWER SOURCE CAUTION

Operate only from a power source indicated on the unit or in this manual. If necessary, have your Electric Utility Service Company or Video Products Dealer verify the power source in your home.

2 POLARIZED OR GROUNDING PLUG

As a safety feature, this product comes with either a polarized power cord plug (one blade is wider than the other), or a three-wire grounding type plug.

POLARIZED PLUG CAUTION:

This plug will only fit into an outlet one way. If you cannot fully insert the plug, try reversing it. If it still will not fit, have an electrician install the proper wall outlet. Do not defeat the safety feature by tampering with the plug.

GROUNDING PLUG CAUTION:

This plug will only fit into a three-hole grounding outlet. If necessary, have an electrician install the proper outlet. Do not defeat the safety feature by tampering with the plug.

3 POWER CORD

Make sure power cords are routed so that they are not likely to have anything rest on them, roll over them, or be in the way of walking traffic. If an extension cord is used, make sure it also has either a polarized or grounded plug and that the cords can be securely connected. Frayed cords, damaged plugs, and damaged or cracked wire insulation are hazardous and should be replaced by a qualified service technician. Overloaded outlets and extension cords are fire hazards and should be avoided.

4 DO NOT BLOCK VENTILATION HOLES

Ventilation openings in the cabinet release heat generated during operation. If they are blocked, heat build-up inside the unit can cause failures that may result in a fire hazard or heat damage to cassettes or discs.

For protection, follow these rules:

- Never cover ventilation slots or the unit while in use, or operate the unit when placed on a bed, sofa, rug, or other soft surface.
- Avoid built-in installation, such as a book case or rack, unless proper ventilation is provided.

5 PLACEMENT: AVOID EXTREMELY HOT LOCATIONS OR SUDDEN TEMPERATURE CHANGES

Do not place the unit over or near heater or radiator, in direct sunlight, inside closed vehicles, in high temperature [over 104°F (40°C)], or in over 75% humidity. If the unit is suddenly moved from a cold place to a warm one, moisture may condense in the unit and on the tape causing damage. Never subject the unit to vibration, impact, or place it so that the surface is tilted as internal parts may be seriously damaged.

6 TO AVOID PERSONAL INJURY

- Do not place unsecured equipment on a sloping surface.
- Do not place this unit on any support that is not firm, level, and adequately strong. The unit could fall causing serious injury to a child or adult and damage to the unit.
- An appliance and cart combination should be moved with care. Quick stops, excessive force, and uneven surfaces may cause the appliance and cart combination to overturn.
- Carefully follow all operating instructions and use the manufacturer's recommended accessories when operating this unit or connecting it to any other equipment.



OUTDOOR ANTENNA INSTALLATION

1 SAFE ANTENNA AND CABLE CONNECTION

If an outside antenna or cable system is connected to the equipment, be sure the antenna or cable system is grounded so as to provide some protection against built up static charges and voltage surges.

Section 810 of the National

Electrical Code, ANSI/NFPA 70

(in Canada, part 1 of the Canadian Electrical

Code) provides information with respect to

proper grounding of the mast and supporting

structure, grounding of the lead-in wire to an

antenna discharge unit, size of grounding conductors,

location of antenna discharge unit, connection to grounding

electrodes and requirements for the grounding electrode.

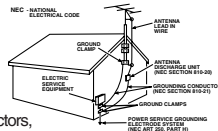

2 KEEP ANTENNA CLEAR OF HIGH VOLTAGE POWER LINES OR CIRCUITS

An outside antenna system should be located well away from power lines, electric light or power circuits and where it will never come into contact with these power sources if it should happen to fall. When installing an outside antenna, extreme care should be taken to avoid touching power lines, circuits or other power sources as this could be fatal. Because of the hazards involved, antenna installation should be left to a professional.

USING THE UNIT

If the unit has been in storage or moved to a new location, refer first to the INSTALLATION section of these safeguards.

1 KEEP THE UNIT AWAY FROM WATER OR MOISTURE OF ANY KIND.

2 IF EQUIPMENT IS EXPOSED TO RAIN, MOISTURE, OR STRONG IMPACT, unplug the unit and have it inspected by a qualified service technician before use.

3 DURING AN ELECTRICAL STORM

During a lightning storm, whether indoors or outdoors, or before leaving the unit unused for extended periods of time, disconnect all equipment from the power source as well as the antenna and cable system.

4 WHEN THE UNIT IS PLUGGED IN

- Never expose the unit to rain or water. **DO NOT OPERATE** if liquid has been spilled into the unit. Immediately unplug the unit, and have it inspected by a service technician. Fire and shock hazards can result from electrical shorts caused by liquid contact inside.
- Never drop or push any object through openings in the unit. Some internal parts carry hazardous voltages and contact can cause electric shock or fire hazard. Do not put any foreign object on the disc tray.
- Avoid placing the unit directly above or below your TV set as this may cause electrical interference. Keep all magnets away from electronic equipment.

5 USING ACCESSORIES

Use only accessories recommended by the manufacturer to avoid risk of fire, shock, or other hazards.

6 CLEANING THE UNIT

Unplug the unit. Then, use a clean, dry, chemically untreated cloth to gently remove dust or debris. **DO NOT USE** cleaning fluids, aerosols, or forced air that could over-spray, or seep into the unit and cause electrical shock. Any substance such as wax, adhesive tape, etc. may mar the cabinet surface. Exposure to greasy, humid, or dusty areas may adversely affect internal parts.

SERVICE

1 DO NOT SERVICE THIS PRODUCT YOURSELF

If, after carefully following the detailed operating instructions, this product does not operate properly, do not attempt to open or remove covers, or make any adjustments not described in the manual. Unplug the unit and contact a qualified service technician.

2 IF REPLACEMENT PARTS ARE REQUIRED

Make sure the service technician uses only parts specified by the manufacturer, or those having the same safety characteristics as the original parts. The use of unauthorized substitutes may result in fire, electric shock, or other hazards.

3 HAVE THE SERVICE TECHNICIAN PERFORM A SAFETY CHECK

After any service or repairs to the unit, request the service technician to conduct a thorough safety check as described in the manufacturer's service literature to ensure that the unit is in safe operating condition.

Safety Precautions/Mesures de sécurité

⚠ WARNING

To prevent fire or shock hazard, do not expose this equipment to rain or moisture.

⚠ CAUTION

To prevent electric shock, match wide blade of plug to wide slot, fully insert.

AVERTISSEMENT:

Afin de prévenir tout risque d'incendie ou de chocs électriques, ne pas exposer cet appareil à la pluie ou à une humidité excessive.

ATTENTION:

Pour éviter les chocs électriques, introduire la lame la plus large de la fiche dans la borne correspondante de la prise et pousser jusqu'au fond.

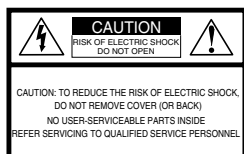

This symbol warns the user that uninsulated voltage within the unit may have sufficient magnitude to cause electric shock. Therefore, it is dangerous to make any kind of contact with any inside part of this unit.



This symbol alerts the user that important literature concerning the operation and maintenance of this unit has been included. Therefore, it should be read carefully in order to avoid any problems.

CAUTION:

UNIT IS A CLASS I LASER PRODUCT.
HOWEVER THIS UNIT USES A VISIBLE LASER BEAM WHICH COULD CAUSE HAZARDOUS RADIATION EXPOSURE IF DIRECTED.
BE SURE TO OPERATE THE UNIT CORRECTLY AS INSTRUCTED.

WHEN THIS UNIT IS PLUGGED TO THE WALL OUTLET, DO NOT PLACE YOUR EYES CLOSE TO THE OPENING OF THE DISC TRAY AND OTHER OPENINGS TO LOOK INTO THE INSIDE OF THIS UNIT.

USE OF CONTROLS OR ADJUSTMENTS OR PERFORMANCE OF PROCEDURES OTHER THAN THOSE SPECIFIED HEREIN MAY RESULT IN HAZARDOUS RADIATION EXPOSURE.

DO NOT OPEN COVERS AND DO NOT ATTEMPT TO REPAIR YOURSELF. REFER SERVICING TO QUALIFIED PERSONNEL.

CAUTION:

LASER RADIATION
WHEN OPEN DO NOT
STARE INTO BEAM.

ATTENTION:

RAYONNEMENT
LASER EN CAS
D'OUVERTURE.
NE PAS REGARDER
DANS LE FAISCEAU.

(Inside of product)

FCC NOTE:

This equipment has been tested and found to comply with part 15 of the FCC Rules. These limits are designed to provide reasonable protection against harmful interference when operated in a residential environment. If this equipment does cause interference to radio or television reception, which can be determined by turning the equipment off and on, use the equipment in another location and/or utilize an electrical outlet different from that used by the receiver.

If necessary, consult the dealer or an experienced radio/TV technician for help. The user may find the booklet, "Something About Interference" available from FCC local regional offices helpful.

FCC Caution:

To assure continued compliance, (example- use only shielded interface cables when connecting to other devices.) Any changes or modifications not expressly approved by the party responsible for compliance could void the user's authority to operate this equipment.

Region Management Information:

This DECK is designed and manufactured to respond to the Region Management Information that is recorded on a DVD disc. If the Region number described on the DVD disc does not correspond to the Region number of this DECK, this DECK cannot play this disc.

- The Region number for this DECK is "1".
- The Player will play DVD-Video marked with labels containing "1" or "ALL".

Example:



Before Using

Congratulations

on your purchase of one of the most sophisticated and reliable products on the market today. Used properly, it will bring you years of enjoyment. Please fill in the information below. The serial number is on the tag located on the back of your DECK.

- Date of Purchase _____
- Dealer Purchased From _____
- Dealer Address _____
- Dealer Phone No. _____
- Model No. **PV-D4734S** _____
- Serial No. _____

Accessories

- Remote Control EUR7724KC0 Batteries 2 "AA" _____

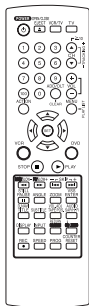

- RF Coaxial Cable LSJA0418



To order accessories, call toll free 1-800-332-5368.

Loading the Batteries

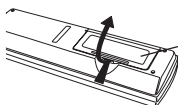
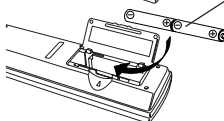
- 1) Open cover. 
- 2) Insert batteries as marked. 
- 3) Close cover.

Battery replacement caution

- Do not mix old and new batteries.
- Do not mix alkaline with manganese batteries.

Record/ Playback Time

Only use tapes with the **VHS** mark in this DECK.

Tape Speed Setting	Type of Video Cassette		
	T120	T160	T180
SP (Standard Play)	2 Hours	2 Hours 40 Minutes	3 Hours
SLP (Super Long Play)	6 Hours	8 Hours	9 Hours

Head Cleaning

Playing older or damaged tapes may eventually cause video heads to become clogged.

Video Head Clog Sensor

During playback, this screen appears if clogging is detected. To remove screen, press PLAY on the remote or DECK.

VIDEO HEADS MAY NEED CLEANING PLEASE INSERT HEAD CLEANING CASSETTE OR REFER TO MANUAL

END :PLAY

- Use "dry" type head cleaning cassette only. (Part No. NV-TCL30PT is recommended.)
- Follow cleaning tape instructions carefully. Excessive use of tape can shorten head life.
- If head clog symptoms persist, contact your nearest servicenter by visiting our Web Site (see p. 61).

Cleaning DECK

Use a soft cloth or dusting attachment of a vacuum cleaner to remove dust from the ventilation holes on the back sides and bottom of the cabinet. Plastic surfaces are easily scratched and can be marred by alcohol and various solvents. Avoid excessive use of oil-based furniture polishes since the materials used in the cabinet will accumulate more dust. We recommend using a non-abrasive, antistatic cleaner and polisher.

Features for a Quality Picture (VCR)

Digital Auto Picture

Automatically controls the video output signal for less noise depending on the tape condition.

Digital Auto Tracking

Continuously analyzes the signal and adjusts for optimum picture quality.

Manual Tracking Control (to reduce picture noise)

Use during Playback and Slow Motion mode to reduce picture noise.

Press CH (TRACKING) ▲/▼ on the remote control or on DECK until the picture clears up.

To return to Auto Tracking, press POWER off, then on again a few seconds later.

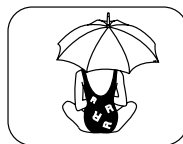
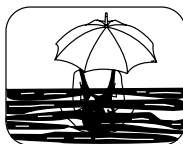

V-Lock Control (to reduce picture jitter)

In Still mode, CH (TRACKING) ▲/▼ operate as a V-Lock control.

Table of Contents

Initial Setup (Connection)		Initial Setup (Connection)
DVD / VCR		
Important Safeguards and Precautions	2, 3	Basic Operation
Before Using	4	
DECK & Cassette Information	6, 7	
Location of Controls	8 ~ 10	
Displays (On Screen Displays and Multi Function Display)	11	
Connections	12 ~ 15	
Initial Setup for Basic Connections (Ready to Play)	16, 17	
Basic Operation		VCR Operation
VCR		
Reset Language, Channels, Clock, VCR's Output Channel ..	18, 19	DVD Operation
Playback/ Record on a Tape	20, 21	
DVD		For Your Information
Basic DVD Operation	22, 23	
VCR Operation		DVD Operation
Timer Recording	24, 25	
MTS Broadcast/ VHS Hi-Fi Stereo System	26, 27	
Multi-Brand Control Feature	28, 29	
Tape Operation (Search System)	30, 31	
Special VCR Features	32 ~ 34	
Copying Your Tapes (Dubbing)	35	
DVD Operation		For Your Information
Disc Operation	36 ~ 41	
DVD-RAM Operation (DVD-RAM only)	42, 43	
DVD Operation using On-Screen Displays	44 ~ 48	
MP3/JPEG Playback Operation	49 ~ 51	
Settings for DVD Operation	52 ~ 55	
Language Code List	56	
For Your Information		
Warning and Instruction Displays	57	
Before Requesting Service	58, 59	
Limited Warranty	60, 61	
Customer Services Directory	61	
Spanish (Español) Quick Use Guide	62 ~ 69	
Index	70, 71	

DECK & Cassette Information

Prevent Accidental Tape Erasure

Break off the tab to prevent recording.



To record again

Cover the hole with cellophane tape.

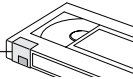

Built-in Head Cleaner

A clean video head helps produce a clear picture. So, we have equipped your DECK with a built-in, non-chemical head cleaning system that helps prevent clogging of the video heads. Cleaning is performed each time you load or unload a video cassette.

- This feature is preventative only. If your video heads are seriously clogged, consider the use of a chemical non-abrasive head cleaning kit or take your DECK to a Servicenter.

Disc formats supported by this DECK

DECK can play back discs bearing any of the following marks:

Logo	Disc type
	DVD-RAM (Version 1.1 of the Video Recording Format a unified video recording standard)
	DVD (DVD-Video)
	DVD-R (DVD-Video formatted discs [finalized])
	CD (CD-DA)
	CD-R/CD-RW • CD-DA format • MP3/JPEG file and finalized.*

[Discs Played 8cm (3") or 12cm (5")]

*A process that allows play on compatible equipment.

Discs which cannot be played

- DVD with Region No. other than "1" or "ALL"
- PAL discs, DVD-ROM, DVD-Audio, DVD-RW, DVD+R, DVD+RW, CD-ROM, CDV, CD-G, CVD, SVCD, SACD, CD-TEXT, Divx Video Disc, Photo-CD and Video CD

Notes

- Do not use irregularly shaped discs (e.g. heart-shaped), as these can damage the unit.
- It may not be possible to play CD-R, CD-RW, DVD-R and DVD-RAM in all cases due to the type of disc or condition of the recording.

DVD-RAM discs

DVD-RAM discs must meet the following conditions for this unit to be able to play them.

Type	<ul style="list-style-type: none"> Non-cartridge discs Discs that can be removed from their cartridges (TYPE 2 and 4)
Capacity	<ul style="list-style-type: none"> 12 cm (5") 9.4 GB (double-sided) and 4.7 GB (single-sided) 8 cm (3") 2.8 GB (double-sided)

- Remove TYPE 2 and 4 discs from their cartridges before use, then return them when you are finished. Read the instructions for the disc carefully.

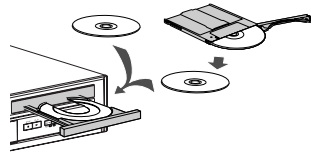

- Some parts of the disc, for example where one program ends and another begins, may not play smoothly.

Disc Handling

Handling precautions

- Sticking a label on the disc may impair DVD-R playback.
- Do not attach sticker to discs. (Do not use discs with exposed adhesive from tape or left over peeled-off stickers.)
- Only hold disc by edges as shown below. Fingerprints, dirt and scratches can cause skipping and distortion.
- Do not write on label side of disc.
- Never use record cleaning sprays, benzene, thinner, static electricity prevention liquids, or any other solvent.

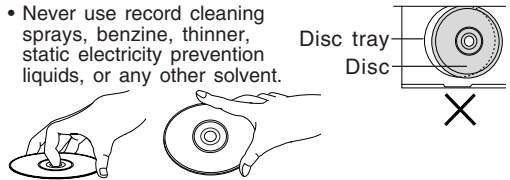

- Do not try to close disc tray when disc is not properly placed.

To clean disc surface

With a soft, damp (water only) cloth, gently wipe from the center hole to the outer edge as shown below. (Wiping in a circular pattern will scratch the surface.)

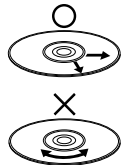

- DVD-RAM, DVD-R :

Clean only with the DVD-RAM disc cleaner available. Never use cloths or cleaners for CDs etc.

If disc is brought from a cold to a warm environment, moisture may form on the disc

Wipe away moisture with a soft, dry, lint-free cloth before using disc. (See above.)

Improper disc storage

Discs could be damaged if stored or left in areas:

- exposed to direct sunlight.
- that are humid or dusty.
- near heat (i.e. heater, radiator, etc.).

Specifications

Power Source:	120 V AC, 60 Hz
Power Consumption:	<u>Power On:</u> Approx. 28 watts, <u>Power Off:</u> Approx. 0.85 watts
Video Signal:	EIA Standard NTSC color
Video Recording System:	4 rotary heads helical scanning system
Audio Track:	1 track (Normal), 2 channel (Hi-Fi Audio Sound)
Tuner	
Broadcast Channels:	VHF 2 ~ 13, UHF 14 ~ 69
CABLE Channels:	Midband A through I (14 ~ 22), Superband J through W (23 ~ 36) Hyperband AA ~ EEE (37 ~ 64), Lowband A-5 ~ A-1 (95 ~ 99) Special CABLE channel 5A (01), Ultraband 65 ~ 94, 100 ~ 125
Input/Output Terminal:	Audio/Video Line Input/Output, RF Input/Output
Input Terminal:	Audio/Video Line Input (Front)
Output Terminal:	S-Video Output (DVD only), Component Video Output (DVD only) Audio Output 2 (L), (R)
Operating Temperature:	5 °C ~ 40 °C (41 °F ~ 104 °F)
Operating Humidity:	10 % ~ 75 %
Weight:	3.85 kg (8.5 lbs).
Dimensions:	430 (W) x 95 (H) x 273 (D) mm 16-15/16" (W) x 3-3/4" (H) x 10-3/4" (D) inch
Discs Played	
(1) DVD-Video Disc	5" (12 cm) single-sided single-layer 5" (12 cm) single-sided double-layer 5" (12 cm) double-sided double-layer (one layer per side) 3" (8 cm) single-sided single-layer 3" (8 cm) single-sided double-layer 3" (8 cm) double-sided double-layer (one layer per side)
DVD-RAM Disc	5" (12 cm) 9.4 GB (double-sided) and 4.7 GB (single-sided) 3" (8 cm) 2.8 GB (double-sided)
(2) Compact Disc	5" (12 cm) disc
(CD-DA)	3" (8 cm) disc
(CD-R/CD-RW, MP3, JPEG)	
Digital Audio Output:	Digital Optical Connector
Pickup:	Wavelength: 655 nm (DVD), 790 nm (CD) Laser power: CLASS II

Note: • Designs and specifications are subject to change without notice.

Definition of Terms (DVD)

Angle:	Some DVD discs feature scenes simultaneously shot from different angles. The ANGLE button can be used to view the scene from different angles. (ANGLE Indicator lights on DECK when a scene recorded at different angles is detected.)
Chapter Number:	Titles are subdivided into numbered sections. You can quickly search for a favorite scene using these numbers.
DVD:	A high-density optical disc on which high-quality pictures and sound have been digitally recorded. DVD incorporates video compression technology (MPEG II) and high-density recording technology which allow entire movies to be recorded with incredible playback quality.
Subtitles:	Written dialogue which appears at the bottom of the screen.
Time Number:	The elapsed play time from the start of a disc or title. Use to quickly find scenes. (May not work with some discs.)
Title Number:	For DVD discs with two or more titles, the title is numbered as title 1, title 2, etc.
Track Number:	Numbers assigned to tracks on CDs to allow specific tracks to be quickly located.

Apparatus Claims of U.S. Patent Nos. 4,631,603, 4,577,216, 4,819,098 and 4,907,093, licensed for limited viewing uses only.

This product incorporates copyright protection technology that is protected by method claims of certain U.S. Patents and other intellectual property rights owned by Macrovision Corporation and other rights owners. Use of this copyright protection technology must be authorized by Macrovision Corporation, and is intended for home and other limited viewing uses only unless otherwise authorized by Macrovision Corporation. Reverse engineering or disassembly is prohibited.

Location of Controls

Remote Control

Bold: VCR Function / **Bold Italic:** VCR and DVD Functions
Italic: DVD Function / Normal: Others

EJECT / OPEN / CLOSE
pp. 20, 22

POWER

NUMBER keys

ADD/DELETE / CLEAR
pp. 19, 39

ACTION
pp. 18, 52

SET

VCR mode
p. 28

STOP
pp. 20, 22

REWIND / SEARCH / SLOW-
pp. 20, 23

FAST FORWARD / SEARCH / SLOW+
pp. 20, 23

PAUSE / STILL
pp. 20, 23

ANGLE
p. 37

SUB TITLE
p. 36

TITLE / DIRECT NAVIGATOR
p. 38, 42

INPUT
p. 35

DISPLAY
p. 11, 44

RECORD
p. 21

SPEED
p. 21

EJECT button: When this button is pressed in VCR mode, the tape is ejected. This button is inoperative if pressed during recording. If pressed in DVD mode, the disc tray opens or closes.

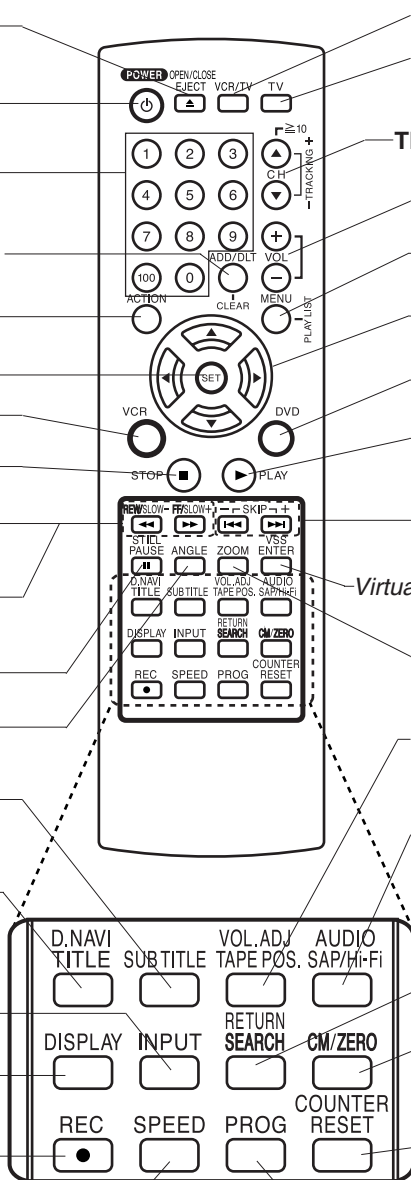

VCR/TV
p. 21

TV mode
p. 28

CHANNEL Δ / ∇ / TRACKING / V-LOCK / ≥ 10
pp. 4, 21, 22

VOLUME + / -
p. 28

MENU / PLAY LIST
p. 38, 43

SELECT
 \blacktriangle \blacktriangledown \blacktriangleleft \blacktriangleright

DVD mode
p. 28

PLAY
pp. 20, 22

SKIP+ $\blacktriangleright\blacktriangleright$ / SKIP- $\blacktriangleleft\blacktriangleleft$
p. 23

Virtual Surround Sound (V.S.S.) / ENTER
pp. 23, 28

ZOOM
p. 37

TAPE POSITION / STATUS VOLUME ADJUST
p. 31, 41

AUDIO (SAP / Hi-Fi)
pp. 27, 36

RETURN / SEARCH
pp. 22, 30

COMMERCIAL SKIP / ZERO SEARCH
pp. 30

COUNTER RESET
p. 30

PROGRAM
p. 24

Front View of DECK

Bold: VCR Function
Italic: DVD Function
Bold Italic: VCR and DVD Functions
 Normal: Others

If the disc cannot be removed...

First, unplug DECK. Then, prepare a rigid wire (e.g. an extended paper clip) and, applying moderate force, insert it straight into the hole at the base of the tray. The tray will eject a little. Now, pull the tray all the way out and remove the disc.

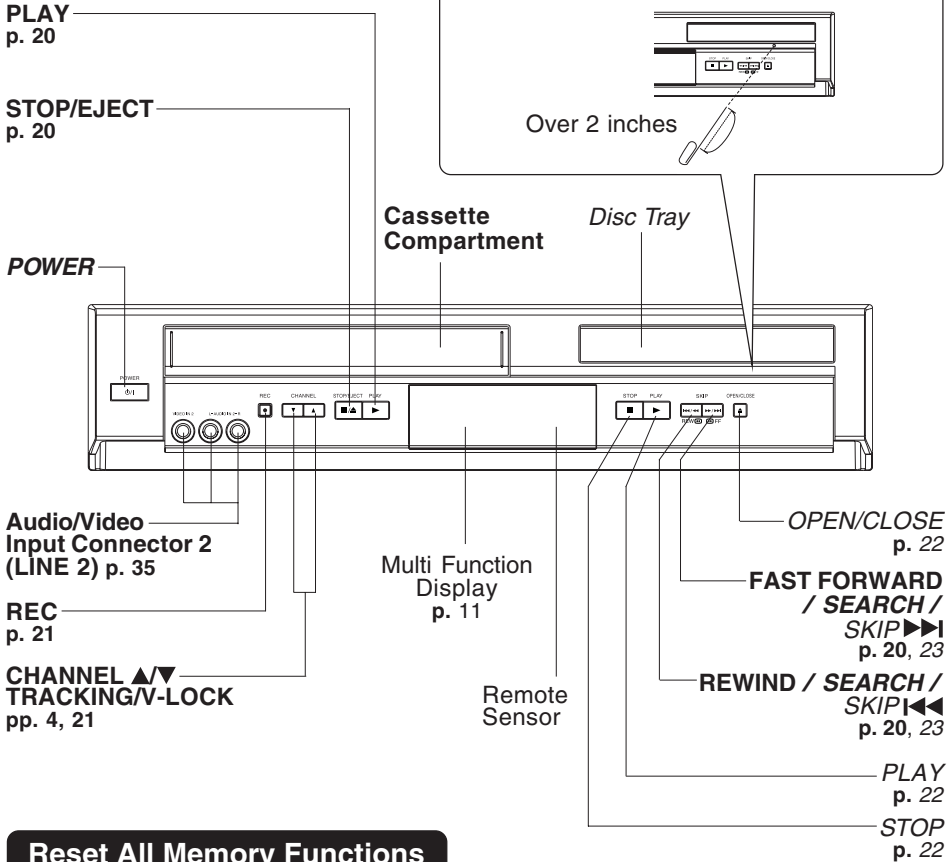

Reset All Memory Functions

Returns to factory setting. Use if relocating DECK, or if Initial Setup needs to be redone.

• Make sure a tape is not inserted in the DECK.

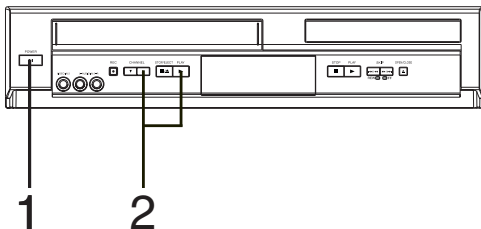

- 1 Turn DECK Power on.
- 2 Press and hold both **VCR PLAY** and **CHANNEL ▲** on the DECK for more than 5 seconds.
 - The power shuts off.
- 3 Perform "Initial Setup (Ready to Play)" on page 16.

Location of Controls (continued)

Rear View of DECK

Bold: VCR Function

Italic: DVD Function

Bold Italic: VCR and DVD Functions

AC Power Plug

- While plugged into an AC outlet, this DECK consumes 0.85 W of electrical power in off mode.

VHF/UHF Antenna Output Terminal
p.12

VHF/UHF Antenna Input Terminal
p. 12

Component Video Output Connector (Y, P_B, P_R) (DVD Only)
p. 13

Video Output Connector
p. 12

Video Input Connector
p. 35

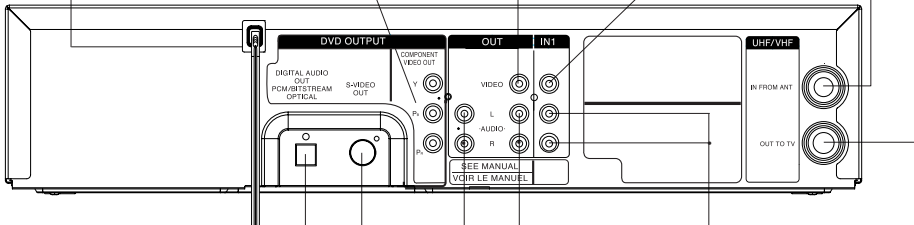

Optical Digital Audio Output Connector (DVD Only)
p. 15

S-Video Out Connector (DVD Only)
pp. 10, 13

Audio Output 1 Connector (L/R)
p. 12

Audio Output 2 Connector (L/R)
p. 13

Audio Input Connector (L/R)
p. 35

The following table shows the status of the output jacks when in VCR or DVD mode.

	Video Output Audio Out 1 Audio Out 2	<i>Component Video Output</i>	<i>S-VIDEO OUT</i>
VCR	YES	N/A	N/A
DVD	YES		YES

Note

- PROG functions on the remote are not available when using Component Video Output and S-VIDEO OUT. Please set TV to either RF INPUT or VIDEO INPUT, and then press PROG.

To enjoy PROGRESSIVE SCAN video

- (1). Connect *Component Video Output* to the component video input terminals of a television. (See p. 13.)
- (2). When PROGRESSIVE OUT is set to "ON" in the DVD Main Menu (p. 55), a Progressive Scan signal is output from the *Component Video Output Connector*.

Notes

- The screen may shift off-center when using progressive output. Please adjust the screen position if this occurs. (Refer to your TV manual.)
- If the television is not progressive compatible, a progressive scan picture is not available. Connect the Video Output or S-Video Output connector (see p. 12, 13) and set PROGRESSIVE OUT to "OFF" in the DVD Main Menu. (See p. 55.)

Displays (On Screen & Multi Function)

On Screen Displays (VCR)

Function & Channel Displays



When a function button is pressed, e.g. PLAY, or you change channels, a 5-second display appears.

Blank Tape/ No Video Signal Indications

Whenever a blank section of a tape comes up in Play mode, or when the selected channel has no broadcast signal with Weak Signal Display Feature (p. 33) set to OFF, the TV screen will turn solid blue.

VCR Status & Clock Displays

To display or remove screen shown at right,

→ press DISPLAY.

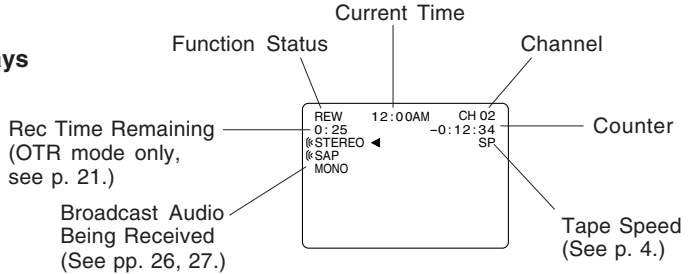

Multi Function Display

VCR mode Indicator

Lights up when DECK is in VCR mode.

Tape Indicator

Lights up when a tape is inserted.

Hi-Fi Indicator

Lights up when Hi-Fi audio is present in Play mode.

ANGLE Indicator

Lights up when a scene recorded at different angles is detected. (See p. 37.) (DVD only)

Clock/ Status/ Channel/ Speed Display

Displays current time. Briefly displays DECK status when you press a function button, channel number or "L1" or "L2" when you select channel or line input, and recording speed when you press SPEED.

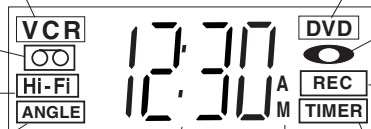

DVD mode Indicator

Lights up when DECK is in DVD mode.

DISC Indicator

Lights up when a disc is inserted.

VCR REC Indicator

Lights up during recording.

AM/PM Indicator

Timer Indicator

Lights up when DECK is set for Timer Recording, or when One Touch Recording (OTR) is used. Flashes when Timer Recording is set, but a tape has not been inserted into DECK and when a power interruption occurs during Timer Programming.

Connections

Basic Connections

- If your TV has AUDIO and VIDEO IN terminals, connect them to DECK for higher quality picture and sound.
- You can enjoy stereo sound even if your TV is not stereo by connecting a stereo amplifier to DECK.
- Connect DECK and TV with an RF Coaxial Cable (a) (supplied) or an AV Cable (b) (not supplied) as shown in the figure below.

■ DSS Receiver → DECK → TV ■ DECK → TV ■ Cable Box → DECK → TV

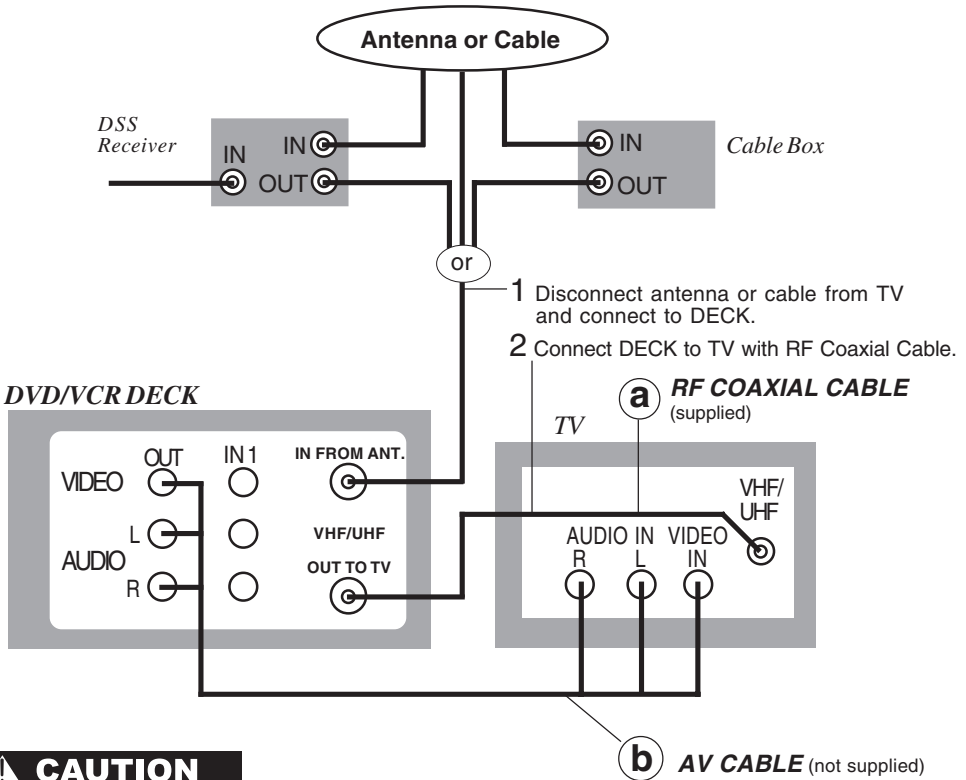

CAUTION

When using "Nut type" RF coaxial cables, tighten with fingers only. Overtightening may damage terminals.

Note to CABLE system installer
This reminder is provided to call the CABLE system installer's attention to Article 820-40 of the NEC in USA (and to the Canadian Electrical Code in Canada) that provides guidelines for proper grounding and, in particular, specifies that the cable ground shall be connected to the grounding system of the building, as close to the point of cable entry as practical.

Other Connections

With a Cable Box (DECK → Cable Box → TV)

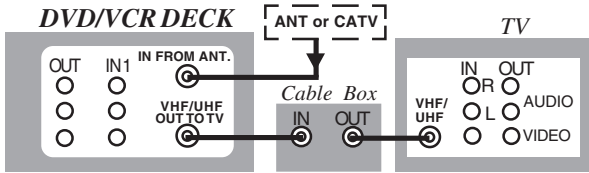

You Can

- view any (including scrambled) channel.
- use Remote Control to select channels without using Multi-brand control feature.

You Cannot

- record scrambled channels.

Connect With Two Cable Boxes

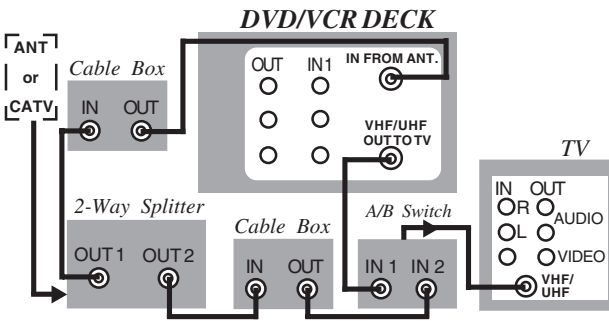

You Can

- record and view both scrambled and unscrambled channels if additional equipment is added. This connection requires: two converter boxes, an A/B switch, and a 2-way splitter.

You Cannot

- view a channel other than the one selected for any type of recording.
- set a Timer recording of a channel unless you select it on the Cable Box.

Connections For DVD Only (enjoying higher picture quality)

- Connect AUDIO OUT2 (L, R) to the AUDIO IN (L, R) of the TV. (audio input for COMPONENT or S-VIDEO mode).
- If your TV has COMPONENT VIDEO INPUT, connect to COMPONENT VIDEO OUT. If your TV does not have COMPONENT VIDEO INPUT but has S-VIDEO INPUT, connect to S-VIDEO OUT.
- When in DVD mode, set your TV to either COMPONENT VIDEO IN or S-VIDEO IN.

Notes

- You can watch DVDs through the S-VIDEO or COMPONENT VIDEO, VHF/UHF OUT TO TV, and VIDEO OUT connections to your TV. The VCR and TUNER pictures are available only from the VIDEO OUT and VHF/UHF OUT TO TV connections to your TV.
- PROG functions on the remote are not available when using S-VIDEO OUT and COMPONENT Video Output. Please set TV to either RF INPUT or VIDEO INPUT, and then press PROG.
- TV must have capability to accept and display a progressive scan signal to use PROGRESSIVE mode. Consult your TV operating instructions.

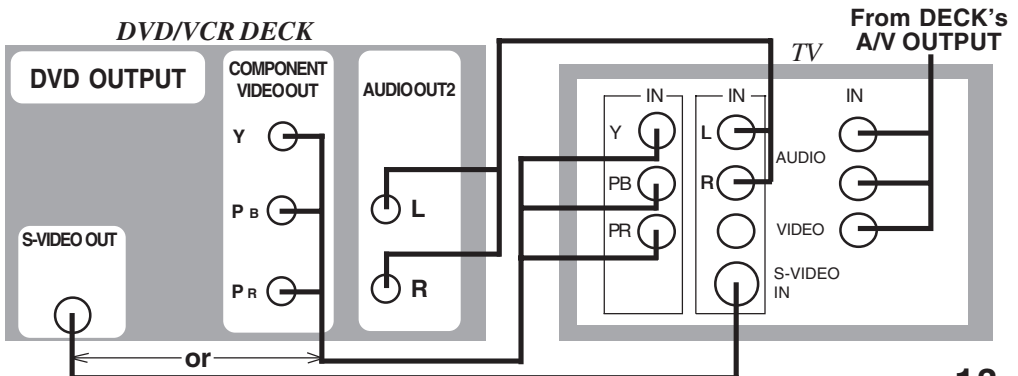

Connections (continued)

Audio Connections

✓ Ready Checklist

- Turn down the volume, then turn DECK, as well as other equipment to be connected, off before proceeding with connection.
- Do not block ventilation holes of any of the equipment and arrange them so that air can circulate freely.
- Read through the instructions before connecting other equipment.
- Ensure that you observe the color coding when connecting audio and video cables.

■ Connecting Amplifier (2ch stereo system)

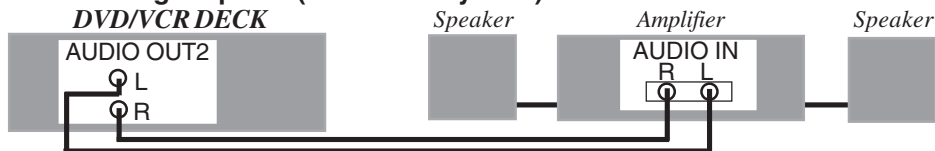

Enjoying digital audio output from the digital audio output connector

Notes on audio output from the optical digital audio output connector

Disc	Sound recording format	Optical digital audio output from connector
DVD-Video	Dolby Digital	Dolby Digital bitstream (1 - 5.1 ch) or PCM (48 kHz sampling/16 bit only)*1
	Linear PCM (48/96 kHz 16/20/24 bit)	Linear PCM (2 ch) (48 kHz sampling/16 bit only)*2
	DTS	Bitstream or PCM (48 kHz sampling/16 bit only)*1
DVD-RAM	Dolby Digital	Dolby Digital bitstream (1 - 5.1 ch) or PCM (48 kHz sampling/16 bit only)
	Linear PCM(48 kHz/16 bit)	Linear PCM (2 ch)
CD	Linear PCM	Linear PCM (44.1 kHz sampling)
MP3	MP3	Linear PCM (It depends on the MP3 file)

*1 The type of audio output from the connector can be selected by the Settings for DVD Operation. (See p. 53.)

*2 When "LPCM(DVD)" is set to OFF in the DVD Main Menu, only 48 kHz sampling/16 bit is output. When set to ON, sampling of sound quality greater than 48 kHz/16 bit is reduced to 48 kHz/16 bit. (See page 53.)

For your reference:

- Dolby Digital is a digital sound compression technique developed by the Dolby Laboratories Licensing Corporation. Supporting 5.1-channel surround sound, as well as stereo (2-channel) sound, this technique enables a large quantity of sound data to be efficiently recorded on a disc.
- Linear PCM is a signal recording format used in CDs. While CDs are recorded in 44.1 kHz/16 bit, DVDs are recorded in 48 kHz/16 bit up to 96 kHz/24 bit.
- If you have a Dolby Pro Logic Surround decoder, you will obtain the full benefit of Pro Logic from the same DVD movies that provide full 5.1 channel Dolby Digital soundtracks, as well as from titles with the Dolby Surround mark. For information on Panasonic or Technics Dolby Pro Logic Surround Sound Decoders please contact your local dealer.

Manufactured under license from Digital Theater Systems, Inc. US Pat. No's. 5,451,942, 5,956,674, 5,974,380, 5,978,762, 6,487,535 and other US. and world-wide patents issued and pending. "DTS" and "DTS 2.0 + Digital Out" are trademarks of Digital Theater Systems, Inc. Copyright 1996, 2003 Digital Theater Systems, Inc. All Rights Reserved.

Manufactured under license from Dolby Laboratories.

"Dolby," "Pro Logic," and the double-D symbol are trademarks of Dolby Laboratories.

■ **Connecting Amplifier (5.1 ch Surround system) [Digital connection]**
DECK → Dolby Digital Decoder → Amplifier → Speaker

or

DECK → DTS (Digital Theater Systems) Decoder → Amplifier → Speaker

When DVDs recorded in Dolby Digital or DTS are played, Dolby Digital bitstream or DTS bitstream is output from the DECK OPTICAL digital audio output connector. When DECK is connected to a Dolby Digital decoder or DTS decoder, you can enjoy theater-quality audio in your home. [An optical digital audio cable (optional) is required when an optional Dolby Digital decoder or DTS decoder is used.]

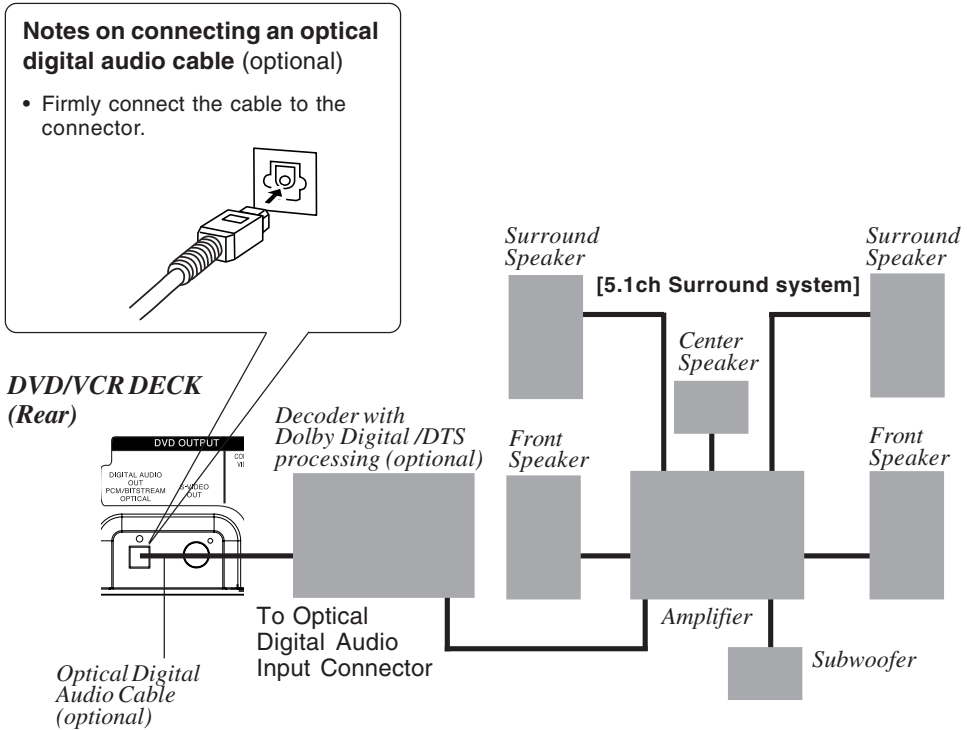

Caution for optical digital audio output connector:

- When connecting an amplifier (with an Optical Digital Input Connector) which does not contain the Dolby Digital or DTS decoder, be sure to select “PCM” at “Dolby Digital” and “PCM” at “dts” of the Settings for DVD Operation “Audio Output” (see p. 53). Otherwise, any attempt to play DVDs may cause such a high level of noise that it may be harmful to your ears and damage your speakers.
- When a Dolby Digital/DTS decoder is connected, please select “Bitstream” at “dts” or “Dolby Digital” of the Settings for DVD Operation “Audio Output”. If “PCM” is selected, there will be stereo sound. (See p. 53.)
- CDs can be played as usual.

Note:

- Some DTS decoders which do not support DVD-DTS interface may not work properly with DECK.

Initial Setup for Basic Connections (Ready to Play)

Before doing Initial Setup

- 1 Turn TV on.
- 2 See connections (a) RF Coaxial Cable Connection and (b) AV Cable Connection on page 12.
<RF Coaxial Cable Connection>
Set TV to **channel 3**.
<AV Cable Connection>
Set TV to **VIDEO**.
- 3 [DECK → TV]
 - Go to “Initial Setup (Ready to Play).” (See below.)[Cable Box → DECK → TV], [DSS → DECK → TV]
 - Turn on Cable Box and set it to your Public Broadcasting Station (PBS) channel in your time zone.
 - If you use a DSS Receiver, it must be turned off.

Initial Setup (Ready to Play)

- 1 Press VCR on remote for VCR mode.
- 2 Plug DECK Power Cord into AC wall outlet. DECK comes on and auto channel and clock set starts.
 - If screen below does not appear, check DECK - TV connection and, if TV is tuned to channel 3, try switching it to channel 4.
 - To change VCR's output channel, please see “VCR's Output Channel” on page 19.

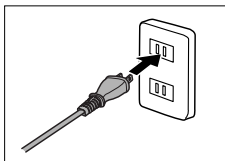

Plug VCR Power plug into an AC wall outlet.

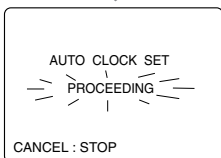
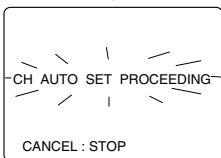

Notes

- Function buttons are void during Initial Setup.
- To eject a tape during Auto Set, press EJECT on remote or STOP/EJECT twice on DECK. Then make settings manually. (See p. 18.)
- If Auto Clock Set takes more than 30 minutes, press STOP and perform settings manually. (See p. 18.)

Continued on next page...

***Important:** If a remote control button does not work when pressed, press the VCR button on the remote and try the button again.

3 Settings are made automatically. When complete, this screen appears.

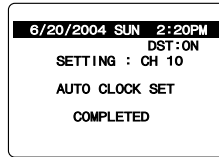
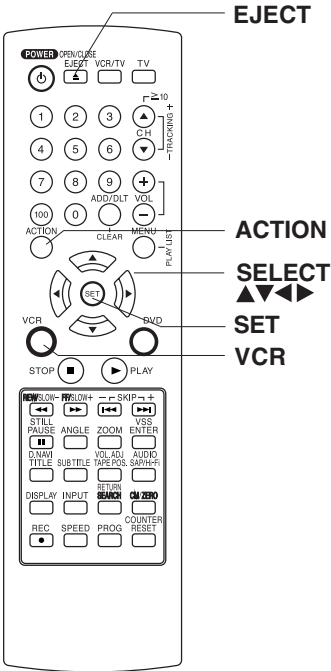

If "AUTO CLOCK SET IS INCOMPLETE" appears, manually set clock (below).

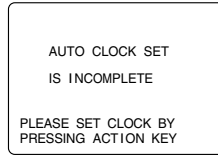

Manual Clock Set

If Auto Clock Set was incomplete.

1 Press ACTION* on remote to display CLOCK screen.

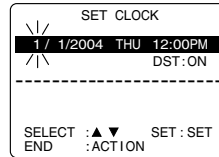

2 Press ▲▼ to select the month and SET to set. In the same manner, select and set the date, year, time, and DST (Daylight Saving Time).

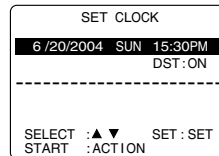

3 Press ACTION to start clock and exit.

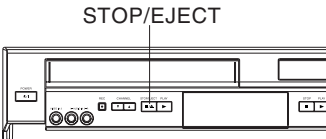

Reset Language, Channels, Clock,

1

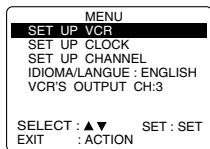

Press **ACTION*** to display MENU.

- PROGRAM functions are not available when using COMPONENT Video Output and S-VIDEO OUT. Please set TV to either RF INPUT or VIDEO INPUT, and then press PROGRAM.

2

Language

- 1) Press **▲▼** to select language item.

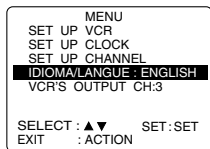

- 2) Press **SET** repeatedly to change language item as shown below.

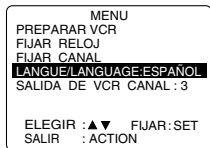

For Spanish ↓

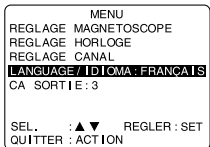

For French ↓

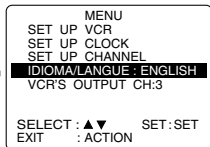

For English

- 3) Press **ACTION** to exit.

Channels

- 1) Press **▲▼** to select "SET UP CHANNEL," and press **SET**.

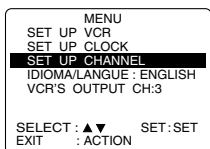

- 2) Press **▲▼** to select "ANTENNA," then press **SET** to set your antenna system ("TV" or "CABLE.")

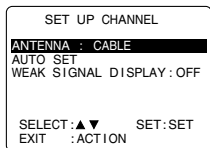

- 3) Press **▲▼** to select "AUTO SET," then press **SET**.

- If you use a Cable Box, set it to the PBS channel in your time zone.

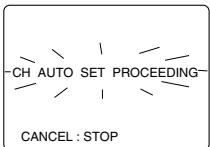

- After Channel Auto Set is finished, Auto Clock Set will be performed.

Clock

- 1) Press **▲▼** to select "SET CLOCK," and press **SET**.

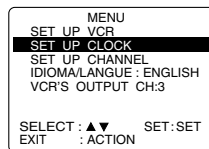

- 2) Press **▲▼** to select "MANUAL," and press **SET**. (For Auto Clock Set, select "AUTO CLOCK SET.")

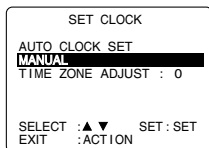

("TIME ZONE ADJUST" appears only when auto clock is set.)

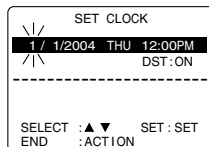

- 3) Press **▲▼** and **◀** to select, then set the date, time, and DST (Daylight Saving Time).
- 4) Press **ACTION** to start Clock and exit this mode.

VCR's Output Channel

***Important:** If a remote control button does not work when pressed, press the VCR button on the remote and try the button again.

Time Zone Adjust

(Only when Auto Clock is set.)

- 1) Press **▲▼** to select "SET CLOCK," and press **SET**.

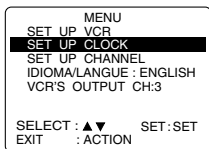

- 2) Press **▲▼** to select "TIME ZONE ADJUST,"

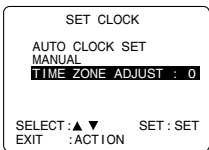

and press **SET** to subtract or add hour(s) as necessary.

- 3) Press **ACTION**.

- "TIME ZONE ADJUST" returns to "0" if clock is set manually.

VCR's Output Channel

- 1) Press **▲▼** to select "VCR'S OUTPUT CH.," and press **SET**.

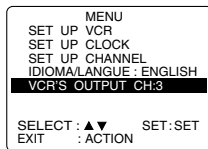

- 2) Press **SET**.

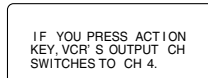

- 3) Press **ACTION**.

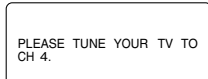

↓ After 3 seconds

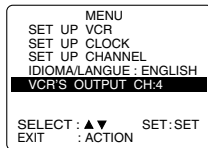

- To Make Corrections, repeat steps 1) ~ 3).

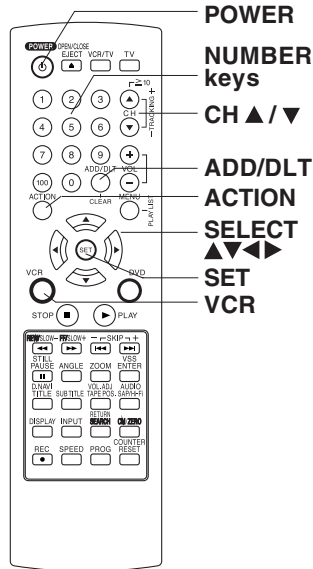

Add or Delete a Channel

To add channel:

Select channel with **NUMBER keys** and press **ADD/DLT**.

CHANNEL 08 ADDED

To delete channel:

Select channel with **CH ▲/▼** or **NUMBER keys** and press **ADD/DLT**.

CHANNEL 08 DELETED

DST (Daylight Saving Time)

DECK auto adjusts clock for DST. (p. 17.)

Spring (First Sunday in April)

DST:ON → Sets clock ahead one hour.

Autumn (Last Sunday in October)

DST:ON → Turns clock back one hour.

- If your area does not observe Daylight Saving Time, select DST:OFF.
- Keep these time changes in mind when programming DECK for timer recordings.

Playback/ Record on a Tape

✓ Ready Checklist

- All connections are made. (pp. 12 ~ 15)
- TV and DECK are plugged in.
- TV is on and tuned to CH 3, 4, or VIDEO.
- Remote is in VCR mode. (Press VCR.)

Playback a Tape

1 Insert a tape.

- DECK power comes on. If Auto VCR/TV (see p. 32) is set to "OFF," press VCR/TV on the remote for VCR mode.

2 Press PLAY* to play a tape.

- If tape has no rec. tab (p. 6), auto play begins.

Special Features During Play

■ Forward/Reverse Scene Search

- ➔ Press FF/SLOW+ or REW/SLOW-.
- ➔ Press PLAY to release.

After search has begun, each additional press of FF or REW changes speed.

Notes

- Picture interruption may occur with some TVs.
- FF and REW search speed may vary depending on current tape position.
- After 10 minutes in search mode, VCR returns to Play mode to protect the tape and the video heads.

■ Still (Freeze) Picture

- ➔ Press PAUSE/STILL.
- ➔ Press PLAY to release.

■ Frame by Frame Picture

- ➔ Press PAUSE/STILL in Still mode.
- ➔ Press PLAY to release.

■ Slow Motion Picture

- ➔ Press FF/SLOW+ (increase speed) or REW/SLOW- (decrease speed) in Still mode.
- ➔ Press PLAY to release.

3 Press STOP to stop a tape.

Rapid Rewind/FF

■ Press REW/SLOW- or FF/SLOW+ in Stop mode to rewind or fast forward a tape.

- Rewinds a T-120 tape in approx. 1 minute.

■ Press EJECT on remote, or STOP/EJECT on DECK to eject a tape.

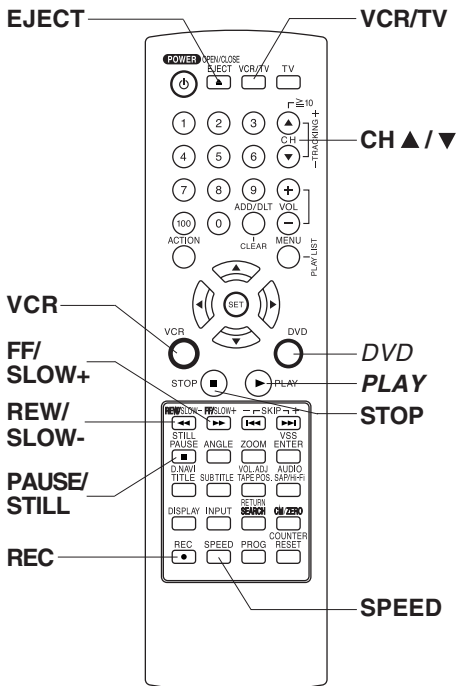

Notes

- These features work best in SP or SLP mode.
- The sound will be muted.
- To reduce picture noise, see "Manual Tracking Control" on page 4.
- After 3 minutes in Still or Slow mode, VCR stops to protect the tape and the video heads.

Playback using DECK buttons

- 1 Insert a tape.
- 2 Press PLAY.

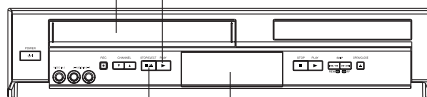

- Press STOP/EJECT to stop and/ or eject a tape.

***Important:** If a remote control button does not work when pressed, press the VCR button on the remote and try the button again.

Record on a Tape

- 1 Insert a tape with a record tab (p. 6).**
 - DECK power comes on. If Auto VCR/TV (see p. 32) is set to "OFF," press VCR/TV on the remote for VCR mode.

- 2 Press CH ▲▼, or NUMBER keys** to select the channel.
 - If channel number is over 100, first press 100 key then the other 2 digits.
 - For "LINE" input, see p. 35.

- 3 Press SPEED** to select the record speed (p. 4).
 - SP = Standard Play
 - SLP = Super Long Play
 - Speed appears on-screen and on Multi Function Display.

- 4 Press REC** to start recording.

(The VCR REC indicator lights up on Multi Function Display),

 - To edit out unwanted scenes, **press PAUSE/STILL** to pause, and again to resume recording.
 - You cannot view another channel during recording.

- 5 Press STOP** to stop recording.

This video recorder, equipped with HQ (High Quality) system, is compatible with existing VHS equipment. Only use tapes with the **VHS** mark. Only tapes tested and inspected for use in 2, 4, 6, and 8 hour machines are recommended.

Note
Remove loose or peeling labels from tapes to prevent tape jam.

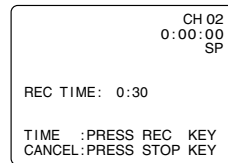
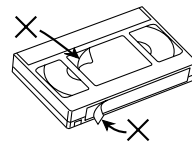

<One Touch Recording screen>

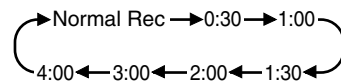

- **One Touch Recording** (recording in progress),
 - **press REC** repeatedly to set the recording length (30 min. ~ 4 hours) (see right).
 - DECK shuts off after the preset record length.
- **Record one station, watch another,**
 - **press VCR/TV** on the remote (change to TV mode),
 - select channels at TV (recording continues).
- **Select Channels at DECK** (In Stop or Rec. Pause mode)
 - **press VCR/TV** on the remote (change to TV mode),
 - select channels at DECK.
- **Play a disc while recording a tape.**
 - insert a disc during recording,
 - **press DVD**, and then **press PLAY**.

Notes

- **It is not possible to record from DVD/ CD to VHS tape using DECK.**
- **Watching one channel and recording another is not possible when using Cable Box or DSS Receiver.**
- After 5 minutes in Pause mode, DECK stops to protect a tape and video heads.

Record using DECK buttons

- 4 Press REC to start recording.
 - 1 Insert a tape.
 - 2 Select Channel.
 - Multi Function Display
 - Press STOP/EJECT to stop.
-

Basic DVD Operation

✓ Ready Checklist

- All connections are made. (pp. 12 ~ 15)
- DECK is plugged in.
- If DECK is connected to an audio amplifier, turn the stereo system's power on.

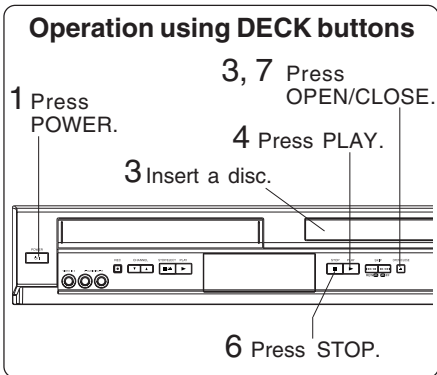
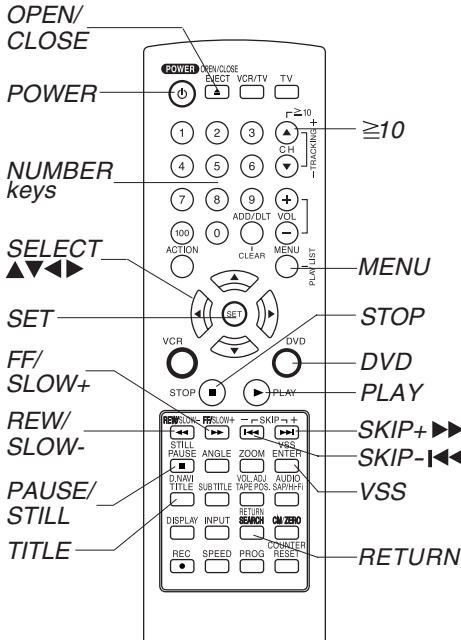

*1 Interactive DVD...
May include multiple camera angles, stories, etc.

1 Press **POWER*** on the remote or DECK.

2 Press **DVD** to select DVD mode.
• If a disc is already inserted, go to step 4. (Depending on the disc, playback may start automatically.)

3 Press **OPEN/CLOSE**, and then place a disc into the disc tray.

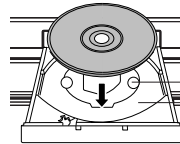

- Hold disc by its edges only (p. 6) with printed side up and use guides to place into tray.
- Use **1** 3" (8 cm) or **2** 5" (12 cm) disc. DVD-RAM → see p. 42

4 Press **PLAY** to start playing. Disc tray closes automatically.

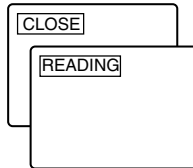

- You may also close tray by pressing **OPEN/CLOSE**.
- Data reading time differs with each disc.

<Example1>

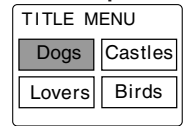

If an interactive DVD*1 is used and **TITLE MENU** appears, go to step 5.

5 Press **▲▼◀▶** or **NUMBER keys** (see below) to select title, and press **SET** or **PLAY** to start playing.
• Pressing **SET** or **PLAY** is not necessary when using **NUMBER keys**.

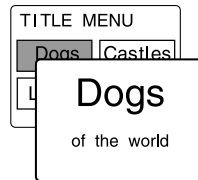

<Example2>

Using NUMBER keys starts play automatically. The number of available titles varies with each disc.

<Input 1 digit number 1...1
Example> 2 digit number 12... ≥ 10 → 1 → 2

Press **SKIP+ ▶▶|** or **SKIP- |◀◀** to go to next or previous menu screen.

- SKIP function not available with all discs. Please refer to disc jacket for operation information.

To return to menu (play stops)
Press **TITLE**, **MENU**, or **RETURN**.

6 Press **STOP** to stop playing.

7 Press **OPEN/CLOSE** to eject the disc.

***Important:** If a remote control button does not work when pressed, press the DVD button on the remote and try the button again.

■ Forward/Reverse Scene Search

Press **FF/SLOW+** or **REW/SLOW-** during play. Press **PLAY** to release.

- Search speed, slow at first, increases with each additional press of the button up to 5 levels.

■ Forward/Reverse Chapter/Track Skip

Press **SKIP+ ►►** or **SKIP- ◄◄** during play. Each press skips a chapter (DVD), track (CD) or Program/Play List/Marker (DVD-RAM).

DVD and CD

- Pressing **SKIP- ◄◄** once midway through a chapter/track returns to the start of that chapter/track. Each additional press skips back one chapter/track.

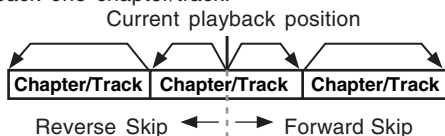

DVD-RAM

- Pressing **SKIP- ◄◄** once midway through a program/play list returns to the start of that program/play list. Each additional press skips back one program/play list.



■ Still Picture or Pause

Press **PAUSE/STILL** during play.

Press **PLAY** to release.

- DVD : DECK will enter still picture mode.
- CD : DECK will enter pause mode.

■ Frame by Frame Picture (DVD)

Press **PAUSE/STILL** in still mode.

Press **PLAY** to release.

- Each press advances picture one frame.
- Hold button down for consecutive frame advance.
- Whether pictures are advanced by "FRAME" or "FIELD" is selected automatically. (See p. 54.)

■ Slow Motion Picture (DVD)

Press **FF/SLOW+** or **REW/SLOW-** in still mode.

Press **PLAY** to release.

- Slow motion speed, slow at first, is increased with each additional press of the button up to 5 levels.

Auto-Power Off Function

Power turns off after DECK has been in Stop mode (DVD) for about 5 minutes.

- When  appears on the screen while a button is being operated, it means that the corresponding operation is prohibited by DECK or the disc.

V.S.S. (Virtual Surround Sound)

Enjoy a surround-like effect if you are using two front speakers only. The effect is broadened and sound seems to come from virtual speakers on either side if the disc has surround signals recorded on it.

Press **VSS** in DVD mode.

- The Surround sound effect can be changed by pressing VSS repeatedly as shown by the figure below.

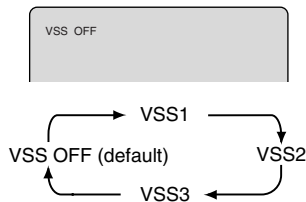

Note

- Surround sound effect is available in DVD mode only.
- Turn off the surround effects on the other equipment.
- V.S.S. will not work, or will have less effect, with some discs.
- Turn V.S.S. off if it causes distortion.
- Sound will only come from the two front speakers if V.S.S. is on.

Resume Function

DECK memorizes the point where STOP is pressed (**STOP ►** is displayed on screen).

Press **PLAY** to resume play from this point.

Pressing **STOP** again or opening the tray cancels RESUME, however, RESUME is not canceled when power is turned off and on.

- RESUME works only with discs for which elapsed play time is displayed during play.
- When a DVD-RAM still picture is played back, the counter will not be displayed, however RESUME will function.

Notes

- Please read the disc jacket for operation information.
- If a single sided disc is placed in upside down, "THIS TYPE OF DISC CANNOT BE PLAYED. PLEASE INSERT A DIFFERENT DISC" is displayed.
- Remove disc and press DECK POWER off when not in use.
- Disc continues to rotate with menu displayed even after play is done. Press STOP to clear menu display when finished with menu.

Timer Recording

✓ Ready Checklist

- All connections are made. (pp. 12 ~ 15)
- TV and DECK are plugged in.
- Clock set correctly. (p. 18)
- Tape has record tab intact. (p. 6)
- Remote is in VCR mode. (Press VCR.)
- Sufficient tape remaining for recording time.

1 Press **PROG***
to display Program.

2

P	DT	START	STOP	CH	SPD
1	--	--:--	--:--	--	--
2	--	--:--	--:--	--	--
3	--	--:--	--:--	--	--
4	--	--:--	--:--	--	--

SELECT : ▲▼ SET: SET
EXIT : PROG

- 1) Press **▶**.
- 2) Set record **DATE**, press **▲▼** to select:
1~31= one time, or
DAILY=Monday~Friday,
or WEEKLY= same time
each week.

• See selection order left.

Example

Today

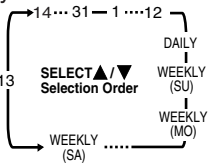

- 3) Set remaining items, press **SET** to set **START/ STOP** times, **CH** (channel) or **LINE** input (p. 35), and tape speed (**SP**, **SLP**). Then press **▲▼** to select.

Press **PROG**
to end programming.

3

P	DT	START	STOP	CH	SPD
1	13	2:00p	3:20p	02	SLP
2	--	--:--	--:--	--	--
3	--	--:--	--:--	--	--
4	--	--:--	--:--	--	--

SET COMPLETED
CANCEL : ADD/HLT
SELECT : ▲▼ SET: SET
EXIT : PROG

To Enter More Programs, press **▲▼** to select and **press SET** to set an unused program number, and then repeat step 2.

Or
Press **PROG**
to exit.

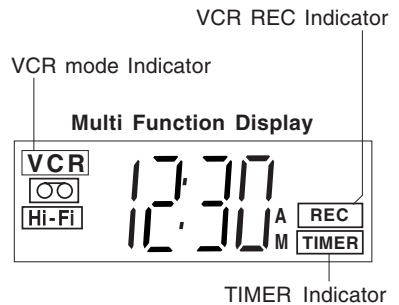
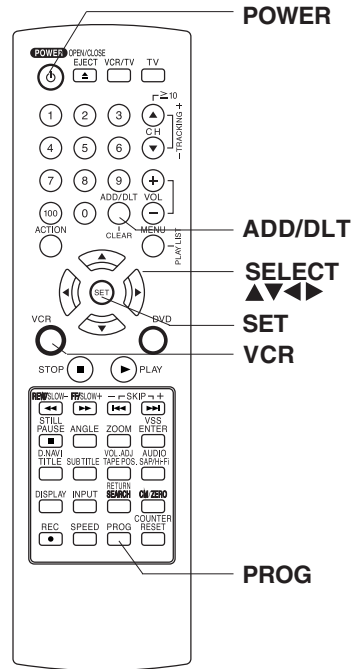

- The “Timer” Indicator lights up on DECK.
- You can set Timer Recording with the power on or off.
- “**TIMER REC WILL START SOON**” appears on-screen for 2 minutes before Timer Recording starts. If DECK is in DVD mode, no message appears, but the VCR REC Indicator, the VCR mode indicator and “REC” will flash on Multi function Display.

***Important:** If a remote control button does not work when pressed, press the VCR button on the remote and try the button again.

Review, Replace or Clear Program Contents:

(Recording is not in progress)

1 Press **PROG**
to display Program List.

2 Press **▲▼**
to select number.

P	DT	START	STOP	CH	SPD
1	13	2:00p	3:20p	02	SLP
2	14	7:00p	7:30p	10	SP
3	--	--	--	--	--
4	--	--	--	--	--

▼

CANCEL	: ADD/DLT
SELECT	: ▲▼ SET:SET
EXIT	: PROG

To cancel a Timer Recording in progress...

Hold down **STOP** in VCR mode for a few seconds to cancel the Timer Recording.

(The "TIMER" Indicator goes out on Multi Function Display.)

- Any future daily or weekly recording will be performed as programmed.

3 To Replace program...

P	DT	START	STOP	CH	SPD
1	13	2:00p	3:20p	02	SLP
2	14	7:00p	7:30p	10	SP
3	--	--	--	--	--
4	--	--	--	--	--

▼

SELECT	: ▲▼ SET:SET
EXIT	: PROG

Repeat Step 2 (p. 24)
to set new programs.

or

To Clear program...

P	DT	START	STOP	CH	SPD
1	--	--	--	--	--
2	14	7:00p	7:30p	10	SP
3	--	--	--	--	--
4	--	--	--	--	--

▼

SELECT	: ▲▼ SET:SET
EXIT	: PROG

Press **ADD/DLT**.

4 Press **PROG**
to end the programming.

Notes

- If you are using a Cable Box, the VCR's channel for Timer Recording must be set to the Cable Box input channel and Cable Box must be manually set to the desired channel. Cable Box power must be left on.
- 2 minutes before Timer Recording is performed, "PLEASE PREPARE FOR TIMER REC" appears and Timer Indicator flashes.
Be sure a cassette with record tab is loaded and DECK is in Stop mode.
- If a power interruption occurs while programming the timer, the timer program(s) may be canceled. If "TIMER PROGRAMS WERE LOST DUE TO POWER INTERRUPTION" appears on-screen, please re-enter the timer programs.
- If the start time for Timer Recording comes up during recording and playing back, Timer Recording will not be performed.

Important notes when using DSS Receiver

- When recording programs via DSS Receiver, DSS Receiver must be left on.
- When recording programs via an antenna or cable, DSS Receiver must be turned off.

MTS Broadcast/ VHS Hi-Fi Stereo System

Connection

Make the Audio/Video Connection as shown on pp. 12 ~ 15.

- You can use TV connected to a Stereo amplifier and speakers instead of Stereo TV.

Receivable Broadcast Types

The following are possible audio broadcast types and on-screen displays.

The signal being received is indicated with a “Ⓜ” mark while the selected audio mode is indicated with an arrow.

To display the broadcast signal being received,

➔ **press DISPLAY*.**

MTS Stereo and SAP broadcast

Multi-channel Television Sound Stereo (main language) and Secondary Audio Program (sub language) broadcasts are being received simultaneously. Select STEREO or SAP audio mode.

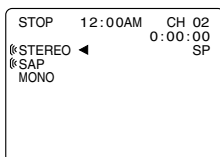

MTS Stereo broadcast

Multi-channel Television Sound Stereo broadcast. Select STEREO audio mode.

- If stereo broadcast is weak and display flickers, select MONO audio mode for possible better results.

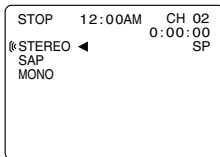

SAP broadcast

Secondary Audio Program (sub language) broadcast. Select SAP audio mode for the sub language.

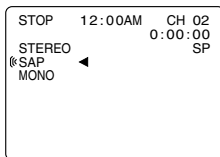

MONO broadcast

Normal monaural sound broadcast.

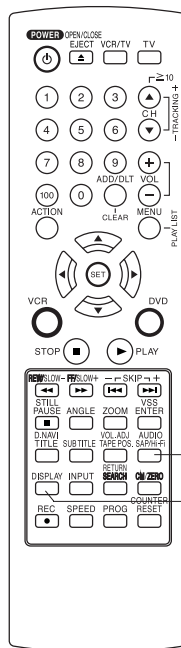
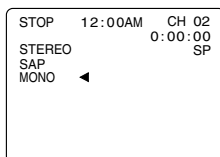

AUDIO (SAP/Hi-Fi)
DISPLAY

Equipped with **dbx®-TV Noise Reduction** for true MTS reproduction. **dbx®-TV Noise Reduction** is required for good stereo separation and audio fidelity. **dbx®** is a registered trademark, and is licensed by **dbx® Technology Licensing.**

***Important:** If a remote control button does not work when pressed, press the VCR button on the remote and try the button again.

Audio Mode for Recording

1 Press AUDIO (SAP/Hi-Fi)

to display audio mode.

(Display disappears after 5 seconds.)

2

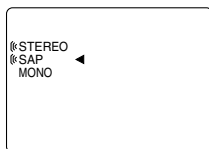

Press AUDIO (SAP/Hi-Fi) repeatedly to select desired mode.

- Refer to “Receivable Broadcast Types” on p. 26.
- Arrow indicates selection.

3 Make a recording.

See p. 21.

Audio Mode for Playback

1 Start playback.

See p. 20.

2 Press AUDIO (SAP/Hi-Fi)

to display audio mode.

3

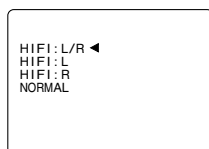

Press AUDIO (SAP/Hi-Fi) repeatedly to select desired mode.

- Select “HIFI (L/R)” or “HIFI (L)” or “HIFI (R)” to listen to stereo recordings in stereo sound. Select “NORMAL” for monaural sound.
- Display disappears after 5 seconds.
- Arrow indicates selection.

Notes

- Only tapes recorded in Hi-Fi stereo will playback with true stereo sound. Standard stereo tapes will playback in monaural sound.
- To listen to Hi-Fi stereo playback, the DECK AUDIO (L/R) jacks must be connected to a stereo TV or an external stereo amplifier and speakers. (See pp. 12, 14.)
- If tracking is adjusted during playback, Hi-Fi audio may revert to normal audio.
- Hi-Fi and normal audio playback volume level may differ.

Multi-Brand Control Feature

Multi-Brand Control Setup

The Remote Control can be set to control some TVs.

1 Find your TV Brand Code Number on the following page.

2 ■ Set up for TV control,
→ hold down TV button,
→ enter code with NUMBER keys.

3 Confirm code entry,
→ press POWER to turn selected unit on or off.
• See table below for controllable functions in each mode.

- Notes**
- Repeat setup after remote battery replacement.
 - Remote will not control every TV made by the manufacturer listed. If you get no response, your particular unit cannot be controlled. There are NO additional codes for the products listed. If your product is not listed, then the remote is not compatible with that product.

Using Multi-Brand Control

After remote is set up, you can select VCR, DVD, or TV for the desired function.

Press **VCR, DVD, or TV** on the remote.

(Table below shows available remote buttons for each mode.)

Unit Mode	DVD/VCR	TV
DVD VCR	All	VOL +/-
TV	EJECT/OPEN/CLOSE* , DISPLAY, PLAY, STOP, FF/SLOW+, REW/SLOW-, VCR/TV, PAUSE/STILL, SKIP, AUDIO, CM/ZERO, SPEED, REC, TAPE POSITION, PAGE, COUNTER RESET	POWER, INPUT, NUMBER keys, ENTER, CH ▲/▼, VOL +/-

* **Bold:** VCR Function
Italic: DVD Function

Bold Italic: VCR and DVD Functions
Normal: TV

Notes

- Not all functions listed may be controllable.
- In TV mode, it may be necessary to press ENTER after pressing NUMBER keys for channel selection.

TV Brand Code Numbers

Panasonic	01, 02	Toshiba	09
Quasar	01, 02	Sanyo	10
RCA	03	Fisher	10
GE	03	JVC	11
Zenith	04	Hitachi	12
Magnavox	05	Mitsubishi	07, 13
Sylvania	05	Samsung	14
Sharp	06, 07	Gold Star	15, 16, 17
Sony	08		

Important Notes

- Some manufacturers use several codes for one brand. If the first code entered fails, try the next one listed.
- Some TVs require you to turn on the power manually.

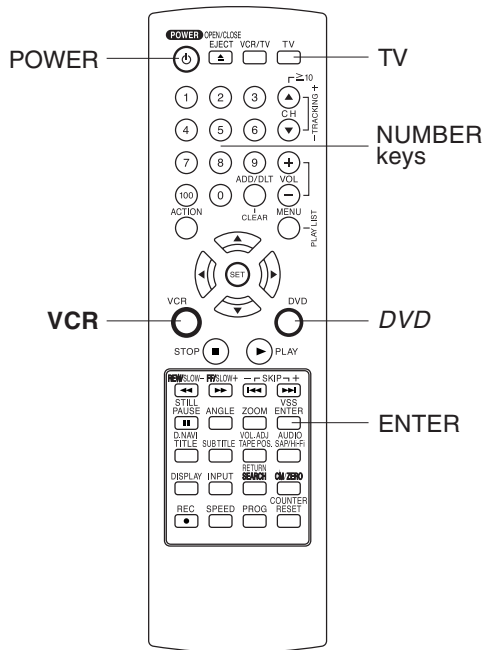

Tape Operation

Search System

For each recording, an invisible index mark is placed on the tape. A program index and information are also included for timer recordings. These marks are used to access or scan recordings.

Index Search

1

```
INDEX SEARCH
ENTER INDEX NUMBER :1
USING 1- 9 KEYS
FORWARD SEARCH :FF
REVERSE SEARCH :REW
EXIT :SEARCH
```

Press **SEARCH*** to display **SEARCH** in Stop or Play mode, and then press **NUMBER** keys to select recording number.

- To calculate number, see below.

Press **FF/SLOW+** or **REW/SLOW-** on the remote to start search.

2

```
INDEX SEARCH

FORWARD SEARCH : FF
REVERSE SEARCH : REW
```

Play begins at search end. To search forward or back 1 index, press **FF/SLOW+** or **REW/SLOW-** on the remote while screen left is displayed (10 sec.).

- To cancel, press **PLAY** or **STOP**.

To Calculate Index Number

Example 1:

To go to rec. 2 from rec. 4, enter 3 and press REW.

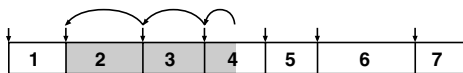

Example 2:

To go to rec. 6 from rec. 2, enter 4 and press FF.

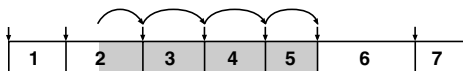

NOTE: ↓ indicates start points of each recording.

Note

- If Index Search is started very close to an index mark, that index mark may not be counted in the search.

Zero Search

To quickly return to a specified tape location.

1

Press **DISPLAY** during play to display Counter.

2

```
PLAY 12:00AM 0:00:00
SP
```

Press **COUNTER RESET** on remote at desired position to reset to "0:00:00".

3

Continue to record, playback etc.

4

Press **STOP**.

5

```
REW 12:30AM CH 02
0:30:30 SP
↓
STOP 12:31AM CH 02
0:00:00 SP
```

Press **CM/ZERO** in Stop mode to start Zero Search.

- DECK will go into FF or REW mode and stop at the last point the Counter was set to 0:00:00.

Commercial Skip

DECK fast forwards (skips) over 1, 2, or 3 minutes of recorded tape as desired.

1

Press **CM/ZERO** in Play mode.

- The skip time can be changed by pressing **CM/ZERO** repeatedly as shown by the figure below.

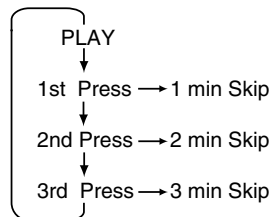

- No indication appears on-screen.

***Important:** If a remote control button does not work when pressed, press the VCR button on the remote and try the button again.

Tape Select

Select your tape length so the tape position and amount of tape remaining are properly displayed.

(See "Tape Position Display" section right.)

1 Press ACTION
to display MENU.

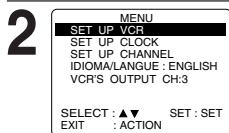

Press ▲▼ to select "SET UP VCR," and press SET.

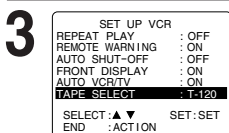

Press ▲▼ to select "TAPE SELECT," and press SET to set "T-120," "T-160" or "T-180."

T-120 → T-160 → T-180

- Select "T-120" for tapes 120 minutes or less, "T-160" if 140 or 160 minutes, and "T-180" if 180 minutes.

4 Press ACTION
to return to normal screen.

Repeat Play

Set to playback a recording over and over.

1 Press ACTION
to display MENU.

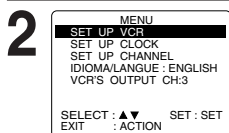

Press ▲▼ to select "SET UP VCR," and press SET.

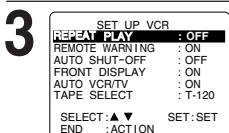

Press ▲▼ to select "REPEAT PLAY," and press SET to set "ON" or "OFF."

- Play repeats at tape end or if unrecorded portion over 30 sec. is detected.

4 Press ACTION
to return to normal screen.

Note

- For repeat play in DVD mode, see page 47.

Tape Position Display

To find out the present tape position and amount of tape remaining.

Tape position is displayed incorrectly in the following cases:

- If VHS-C type cassettes, tapes under 30 minutes, tapes over 180 minutes, or incompatible tapes are used.
- If the correct tape length is not selected. (See "Tape Select" section left.)

1 Press TAPE POSITION
to detect current tape position.

DETECTING TAPE POSITION

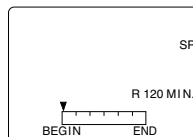

- "DETECTING TAPE POSITION" only appears the first time a cassette is inserted and it takes several seconds for correct indication to appear.
- The present tape position indication and amount of tape remaining (according to tape speed) are displayed. Tape remaining time display may not be precise.

2 Press TAPE POSITION
(or wait 5 seconds) to return to normal screen.

Auto Operation Functions

Auto Play

Insert a tape → Power comes on,
→ Play starts if there is no record tab
(see p. 6).

Auto Rewind

Play
Fast Forward } → Tape end → Rewind → Stop

Play Auto Eject

(Repeat Play must be off)

Play → Tape end → Rewind → Stop
→ Tape ejects if some programs are set.

Special VCR Features

VCR/TV Selection Feature

The VCR/TV selection can be set to auto or manual.

1 Press **ACTION*** to display MENU.

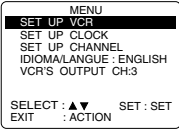

Press **▲▼** to select "SET UP VCR," and press **SET**.

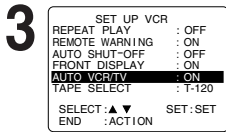

Press **▲▼** to select "AUTO VCR/TV," and press **SET** to set "ON" or "OFF."

- OFF(Manual): You select "VCR" or "TV" mode using the VCR/TV button on the remote.
- ON(Auto): "VCR" mode is automatically set when VCR is turned on, or in Play mode.

4 Press **ACTION** to return to normal screen.

Note

- For more on VCR/TV selection, see "Record one station, watch another" and "Select channels at DECK" sections (see p. 21).

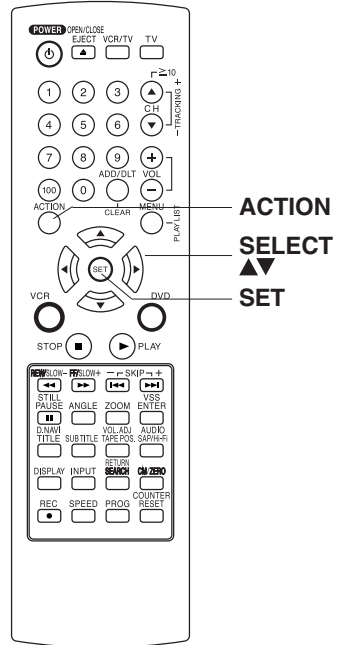

VCR Lock Feature

When set to ON, all operations except for timer record and tape eject are prohibited. Useful for households with small children.

To turn on, hold down REC on DECK in Stop mode with no tape inserted for 7 seconds. (Please ignore "NO CASSETTE" warning.)



To turn off, repeat above.

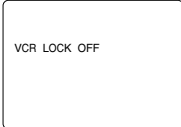

- VCR Lock cancels in 24 hours.

Note

- DVD functions will work even when VCR Lock is set to ON.

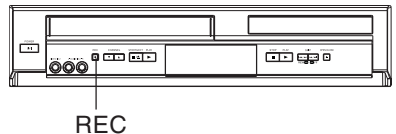

***Important:** If a remote control button does not work when pressed, press the VCR button on the remote and try the button again.

Weak Signal Display Feature

When "ON," picture is displayed regardless of signal strength.

1 Press **ACTION** to display MENU.

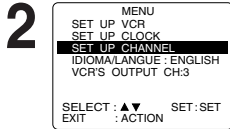

Press **▲▼** to select "SET UP CHANNEL," and press **SET**.

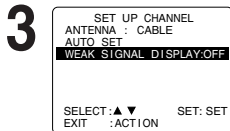

Press **▲▼** to select "WEAK SIGNAL DISPLAY," and press **SET** to set "ON" or "OFF."

- ON: Picture is displayed regardless of signal condition, and may not always be clearly visible.
- OFF: Screen turns solid blue when signal is weak or non-existent.
- Selecting ON has no effect on connected equipment with blue back feature.

4 Press **ACTION** to return to normal screen.

Auto Shut-Off Feature

The power shuts off at a preset time.

1 Press **ACTION** to display MENU.

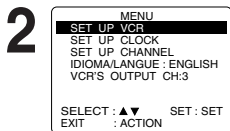

Press **▲▼** to select "SET UP VCR," and press **SET**.

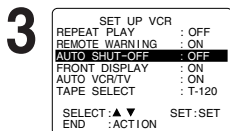

Press **▲▼** to select "AUTO SHUT-OFF." Press **SET** repeatedly to change shut-off time as shown below.

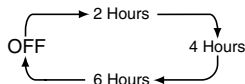

4 Press **ACTION** to return to normal screen.

Note

- The shut-off countdown will not function during Play or Record.

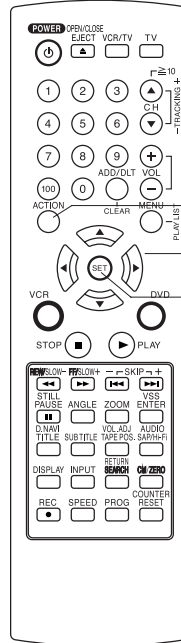

ACTION
SELECT
▲▼
SET

VCR
Operation

Special VCR Features (continued)

Remote Warning Feature

If Multi-brand feature is used (p. 28), and this feature is set to on, a warning appears whenever an invalid key is pressed in TV mode.

1 Press **ACTION*** to display MENU.

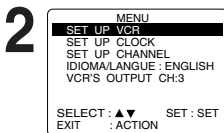

Press **▲▼** to select "SET UP VCR," and press **SET**.

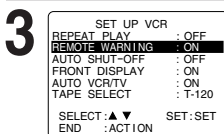

Press **▲▼** to select "REMOTE WARNING," and press **SET** to set "ON" or "OFF."

- If "OFF," remote warning will not appear when invalid key is pressed.

4 Press **ACTION** to return to normal screen.

Multi Function Display (Front Display) ON/OFF Feature

Multi Function Display (Front Display) can be set to ON/OFF.

1 Press **ACTION** to display MENU.

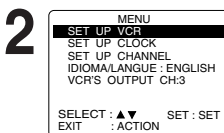

Press **▲▼** to select "SET UP VCR," and press **SET**.

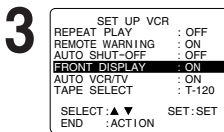

Press **▲▼** to select "FRONT DISPLAY," and press **SET** to set "ON" or "OFF."

- ON : When set to "ON," Multi Function Display is displayed.
- OFF: When set to "OFF," Multi Function Display is not displayed. If a Timer Program is set, Multi Function Display is displayed.

4 Press **ACTION** to return to normal screen.

***Important:** If a remote control button does not work when pressed, press the VCR button on the remote and try the button again.

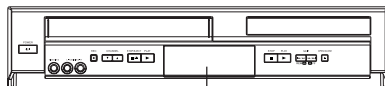
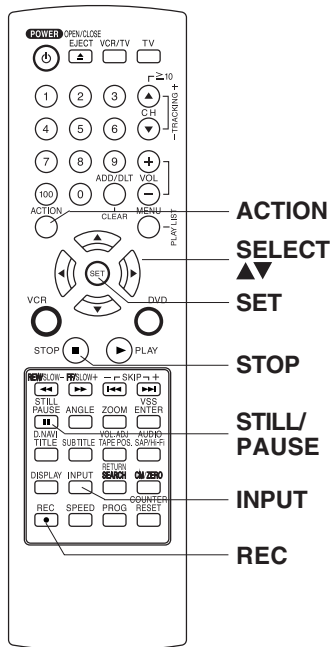

Multi Function Display (Front Display)

Copying Your Tapes (Dubbing)

Connection

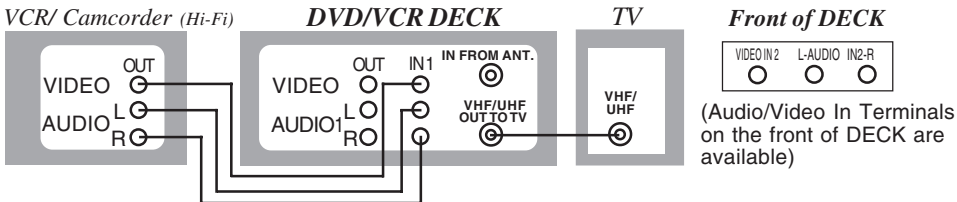

- ① Connect VIDEO OUT terminal on Playing VCR to VIDEO IN terminal on DECK. To monitor the dubbing, also connect TV as shown.
- ② Connect "L" and "R" AUDIO OUT terminals on Playing VCR to "L" and "R" AUDIO IN terminals on DECK.
In place of Playing VCR, you can use other equipment, such as a Camcorder. Simply connect the unit's Audio/Video outputs to DECK.

Playing (Source) VCR

Recording (Editing) DECK

1 Insert a pre-recorded tape.

Insert a blank tape with record tab.

2 _____

Press INPUT to set DECK Input mode to LINE for Video Input.
(See "Selecting the Input Mode" below.)

3 Press **PLAY**, then **PAUSE** immediately to enter PLAY/PAUSE mode.

Press REC, then **STILL/PAUSE** immediately to enter REC/PAUSE mode.

The operation of steps 4 and 5 must be done on the playing and recording VCRs at the same time.

4 Press **PLAY** to start dubbing. Playing VCR starts playback.

Press STILL/PAUSE to start dubbing. DECK starts recording.

5 Press **STOP** to stop dubbing.

Press STOP to stop dubbing.

■ To Monitor Dubbing on TV

- 1 Turn TV on and tune to the Recording VCR channel (CH 3 or CH 4).
- 2 If Auto VCR/TV (see p. 32) is set to "OFF," press VCR/TV on the remote for VCR mode.

■ Selecting the Input Mode

- Method 1: **Press INPUT** repeatedly.
Channel Number ↔ LINE1 ↔ LINE2
- Method 2: **Press CH ▲/▼**.
Display will change as below.

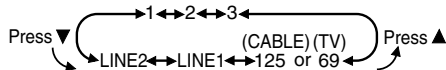

- "L1" or "L2" lights up on Multi Function Display (about 4 seconds) when LINE1 or LINE2 is selected.
- LINE1: For rear audio/video connection.
- LINE2: For front audio/video connection.

Note • Dubbing tapes protected with Copy Guard will result in poor quality recordings.

Caution: •Unauthorized exchanging and/or copying of copyrighted recordings may be copyright infringement.

- Please note that some tapes cannot be dubbed on DECK. Also, it is not possible to dub DVD/ CD to VHS tapes using DECK.
- When  appears on the screen while a button is being operated, it means that the corresponding operation is prohibited by DECK or the disc.

Disc Operation

Subtitle Language (DVD only)

You can select a different subtitle language (if offered) than the one set at the Settings for DVD Operation. (See p. 52.)

1

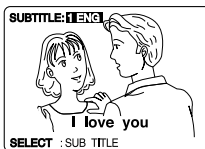

Press **SUB TITLE*** in Play mode to display the subtitle selection on-screen.

- Display disappears after 5 seconds.
- When no subtitles are offered, “-” will be displayed instead of the language number.

2



Press **SUB TITLE**, **▲▼**, or **NUMBER** keys to select a desired language.

Subtitle language being played back (see chart, right).

Notes

- If after several presses of the button the language does not change, language selection is not offered on the disc.
- When disc is removed, subtitles revert to initial setting language. If the initial language is not recorded on the disc, the disc's priority language will appear.
- With DVD-RAM, the subtitle can only be set to ON/OFF. The subtitle language cannot be selected.
- Subtitles may not change to the selected language immediately.

Audio Soundtrack Language (DVD only)

You can change the audio soundtrack language, selected at the Settings for DVD Operation, to a different language if available. (See p. 52.)

(This operation works only with discs on which multiple audio soundtrack languages are recorded.)

1

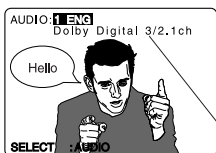

Press **AUDIO** in Play mode to display the audio selection on-screen.

- Display disappears after 5 seconds.

Information of the audio stream currently being played back is displayed. (See page 53.)

2

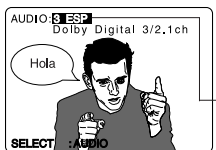

Press **AUDIO**, **▲▼**, or **NUMBER** keys to select desired language.

Audio soundtrack language being played back (see chart, above right).



Ready Checklist

- Please read “Basic DVD Operation” on page 22.

[Subtitle language]

[Audio sound track language]

ENG	English
FRA	French
DEU	German
ITA	Italian
ESP	Spanish
NLD	Dutch
SVE	Swedish
NOR	Norwegian
DAN	Danish
POR	Portuguese
RUS	Russian
JPN	Japanese
CHI	Chinese
KOR	Korean
MAL	Malay
VIE	Vietnamese
THA	Thai
*	Other

- Change the No. by pressing **▲▼**, and press **SET**.

[Audio attribute 1 type, sampling frequency, bit No. of the disc (see p. 53.)]

LPCM	96 kHz or 48 kHz	16 bit 20 bit 24 bit	Linear PCM disc
Dolby Digital	1c h - 5.1 ch		Dolby Digital disc
DTS	1 ch - 5.1 ch		DTS disc

Notes

- If, after several presses of the AUDIO button the language does not change, language selection is not offered on the disc.
- When disc is removed, language reverts to initial setting. If this language is not recorded on the disc, the language recorded will be heard.
- With DVD-RAM, Audio Soundtrack Language cannot be set. Audio stream and Audio mode (LR/L/R) setting can be made. Audio stream operation method is the same as Audio Soundtrack Language. Press **▶** to move the cursor to Audio mode, then press **AUDIO** or **▲▼** to select LR/ L/ R.



*Important: if a remote control button does not work when pressed, press the DVD button on the remote and try the button again.

When  appears on the screen while a button is being operated, it means that the corresponding operation is prohibited by DECK or the disc.

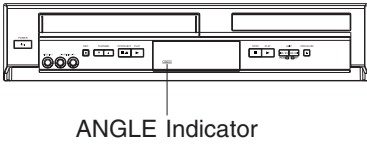

ANGLE Indicator

Notes

- The ANGLE Indicator lights up on DECK when a scene recorded at different angles is detected.
- The angle number can be set beforehand so that the angle is switched whenever the ANGLE Indicator lights up.

Multiple Angle Viewing (DVD only)

DVDs may contain scenes shot from multiple camera angles allowing the same scene to be viewed at different angles. You can view these angles, if available, using the ANGLE button.

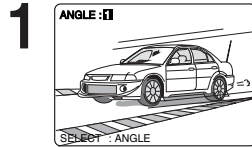

Press ANGLE in Play mode to display the angle selection on-screen.

- Display disappears after 5 seconds.

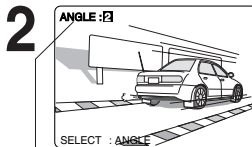

Press ANGLE repeatedly or **▲▼** to select the desired angle.

Number of angle being played back.

Note This function not available with DVD-RAM.

Vocal Selection for Karaoke Discs (DVD only)

1 Press **AUDIO** in Play mode to display the audio screen.

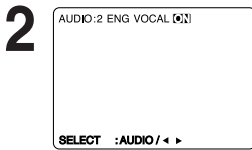

Press ◀▶ to select VOCAL and **press AUDIO** or **▲▼** to select as shown below.

- DVD Karaoke (1 vocal) VOCAL ON--VOCAL OFF
- DVD Karaoke (2 vocals) VOCAL V1--VOCAL V2--VOCAL V1+V2--VOCAL OFF

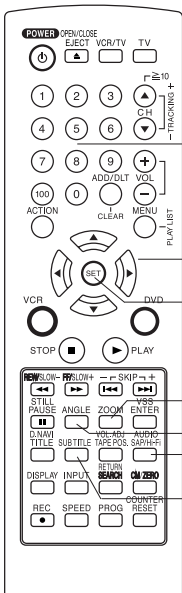

NUMBER keys

SELECT
▲▼◀▶
SET

ZOOM
ANGLE
AUDIO
SUB TITLE

Picture Zoom (DVD only)

You can enlarge specific portions of a picture and select the zoom ratio using the ZOOM button during DVD playback.

Press ZOOM repeatedly to change display as follows.

- You can enlarge the center portion of the image to one of 2 magnifications.

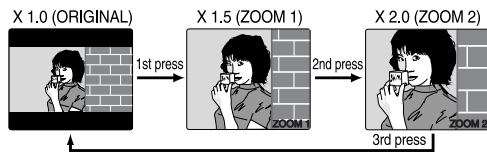

■ Use the **▲, ▼, ◀** and **▶** buttons to move the position up, down, left and right.

Notes

- The subtitle cannot be enlarged or moved.
- During picture zoom, "ZOOM1" or "ZOOM2" appears on-screen for 5 seconds.
- Zooming, on some discs, may result in poor picture quality, or may not operate at all.

DVD Operation

Disc Operation (continued)

Title Menu (DVD only)

Some DVDs have more than one title, e.g. movies. If the disc offers a title menu, you can select the desired title number. (Operation may vary according to the disc.)

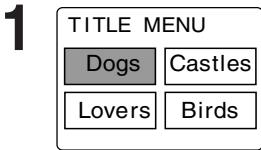

<Example>

Press **TITLE*** in Play mode to display the title screen.

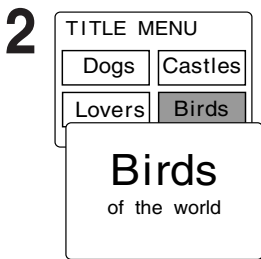

<Example>

Press **▲▼◀▶** or **NUMBER** keys to select a title, and press **SET** or **PLAY** to start playing.

- “Pressing **SET** or **PLAY**” is not necessary when using **NUMBER** keys.

DVD Menu (DVD only)

DVDs may offer a special menu. This menu may include guides to unique contents, audio/subtitle languages, etc. Although contents and operation may vary, the following steps show basic procedure for using the menu.

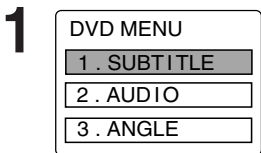

<Example>

Press **MENU** in Play mode to display DVD MENU.

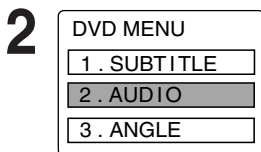

<Example>

Press **▲▼◀▶** or **NUMBER** keys to select an item, and press **SET** or **PLAY** to perform.

- Pressing **SET** or **PLAY** is not necessary when using **NUMBER** keys.

Repeat step 2 if there is more than one menu.

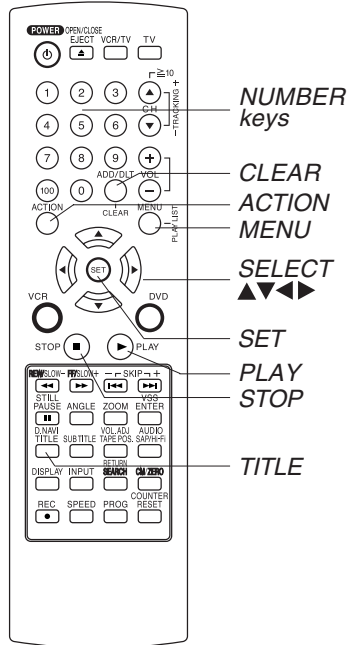

*Important: if a remote control button does not work when pressed, press the DVD button on the remote and try the button again.

Program Play (CD only)

You can program specific tracks and order of play.

1 Press **ACTION** to display DVD MAIN MENU.

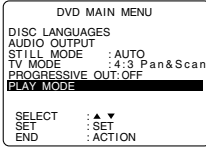

Press **▲▼** to select “PLAY MODE,” and press **SET** to display.

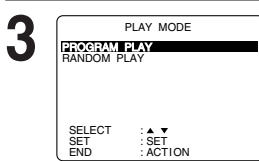

Press **▲▼** to select “PROGRAM PLAY,” and press **SET** to display.

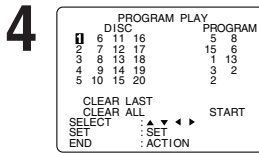

Press **▲▼◀▶** to select a track number (Track numbers on disc are displayed.), and press **SET**.

- Repeat step 4 to select another track.
- The selected track is added on the right side.

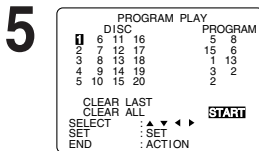

Press **▲▼◀▶** to select “START,” and press **SET** to start play of programs in the sequence selected.

- To cancel, press **STOP** during play, then press **CLEAR**.

Notes

- Up to 15 tracks can be programmed.
- “◀” or “▶” (depending on disc) indicates additional PROGRAM PLAY screen. Press **▲▼◀▶** for next or previous screen.
- **To clear the last program one by one**
Press **▲▼◀▶** to move to “CLEAR LAST” and press **SET**. (Pressing **CLEAR** on remote control also clears last program.)
- **To clear all programs**
Press **▲▼◀▶** to move to “CLEAR ALL” and press **SET**. (Programs are also cleared when the power is turned off or the disc is removed.)

✓ Ready Checklist

- DECK is in DVD mode, press DVD.
- CD is inserted.

Program Repeat Play (CD only)

1 Do operation steps 1 through 5 at left on this page.

2 Press **DISPLAY** to display Disc Information screen. (Disc Information Screen)

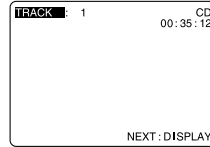

3 Press **DISPLAY** to display DECK Information screen.

4 Press **SET** to enter Select mode. Cursor move to “OFF.” (DECK Information Screen)

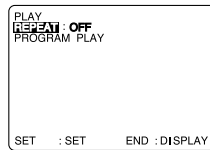

5 Press **▲▼** to select “DISC.” (DECK Information Screen)

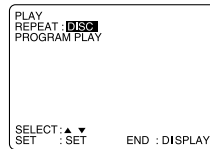

6 Press **SET** to set mode. Cursor moves to “REPEAT.” To cancel, select “REPEAT : OFF” in step 5, then press **SET**.

Disc Operation (continued)

Random Play (CD only)

Tracks are played in a random order.



Ready Checklist

DECK is in DVD mode, press DVD.

1 Press **ACTION*** to display DVD MAIN MENU.



Press **▲▼** to select "PLAY MODE," and press **SET** to display.

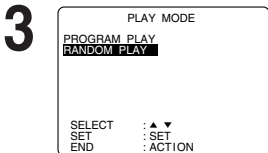

Press **▲▼** to select "RANDOM PLAY," and press **SET** to begin random play.

• To cancel, press **STOP** during play, then press **CLEAR**.

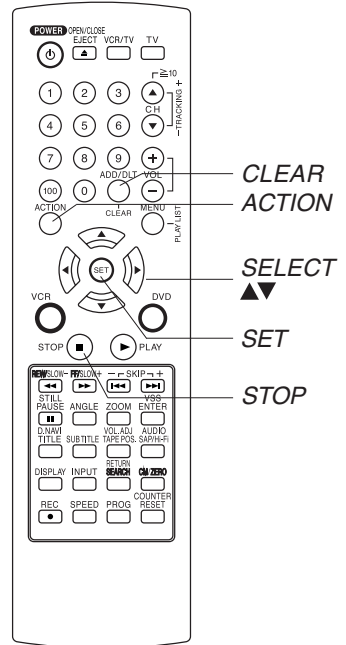

*Important: if a remote control button does not work when pressed, press the DVD button on the remote and try the button again.

Setting the VOLUME ADJUST (DVD only)

Some DVDs are recorded in lower than average volume levels. For these DVDs, this DECK can be set so that the average volume is increased automatically.

Press **VOL.ADJ** repeatedly to change “OFF” ↔ “ON.”

- “OFF” or “ON” lights up on Multi Function Display (about 3 seconds) when VOL.ADJ is pressed.

	VOLUME ADJUST “OFF”	VOLUME ADJUST “ON”
Some DVD [Low volume level]	Volume is at the original level.	Volume level is increased when played back.

- “ON” is set When a DVD is played back, the average volume is increased.
- “OFF” is set The volume level recorded on the disc is played back just as it is.

Notes

- While settings can be made with all discs, they may have no effect with some discs. Please set as you prefer.
- When audio equipment is connected, setting the Sound Output level to “OFF” is recommended.
- If the sound becomes abnormal while playing a disc, set the Sound Output level to “OFF.”

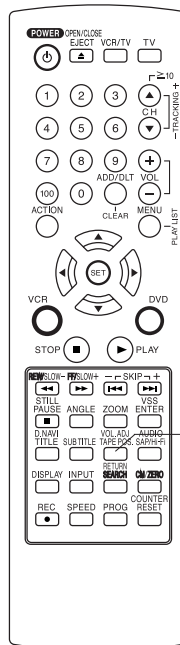

VOLUME
ADJUST

DVD-RAM Operation (DVD-RAM only)

You can enjoy playing your personally recorded/edited DVD-RAM discs on this DECK.

Note

- This DECK was designed for playback only. DVD-RAM recording is not possible.

Play a DVD-RAM

- 1 Do steps 1 ~ 3 on page 22.**
 - Play begins from the first program title recorded on the DVD-RAM.
- 2 Press *D.NAVI** or *PLAY LIST*** to display Direct Navigator or Play List menu for easy title or scene selection.
 - See below for “Direct Navigator” or next page for “Play List information”.
- 3 Press *STOP*** to stop playing.
- 4 Press *OPEN/CLOSE*** to eject the disc.

Direct Navigator

If the DVD-RAM features Direct Navigator, a list of recorded titles is displayed. Simply select a title number and start playback. (Operation can vary with disc used.)

- 1 Press *D.NAVI*** in Play/Stop mode to display the Direct Navigator menu.
- 2 Press ◀▶** to select a page and **press ▲▼** to select a title (Program No.). Then, **press *SET*** or ***PLAY*** to start playing.
 - “Pressing SET or PLAY” is not necessary when using NUMBER keys.

Using NUMBER keys starts playing automatically.
The number of available titles varies with each disc.

<Input 1 digit number 1 ●● 1
Example> 2 digit number 12 ●● ≥10 → 1 → 2
- 3 Press *D.NAVI*** to clear Direct navigator menu.

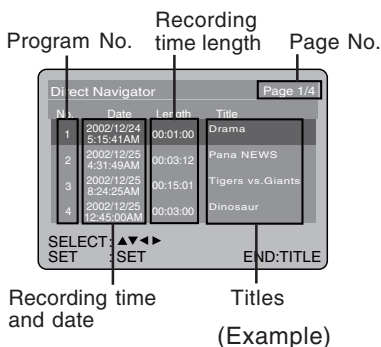

*Important: if a remote control button does not work when pressed, press the DVD button on the remote and try the button again.

Play List

If the DVD-RAM features a Play List, your preselected list of favorite scenes is displayed for easy access. (Operation can vary according to how you edited the DVD-RAM.)

1 Press **PLAY LIST** in Play/Stop mode to display the Play List menu.

2 Press **◀▶** to select a page and press **▲▼** to select a title (Play List No.). Then, press **SET** or **PLAY** to start playing.

- “Pressing SET or PLAY” is not necessary when using NUMBER keys.

Using NUMBER keys starts playing automatically.
The number of available titles varies with each disc.

<Input 1 digit number 1 ... 1
Example> 2 digit number 12 ... $\geq 10 \rightarrow 1 \rightarrow 2$

3 Press **PLAY LIST** to clear Play List menu.

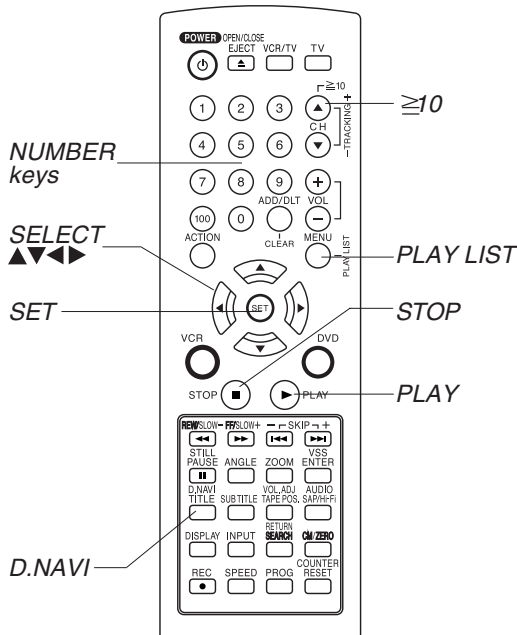
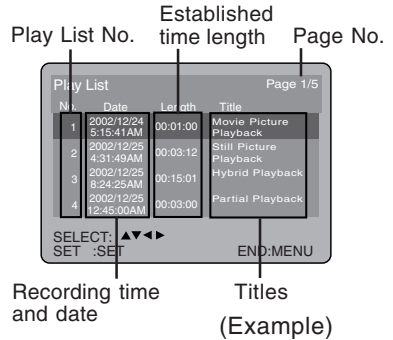

Notes

- Titles of Direct Navigator and Play List cannot be changed using this DECK.
- With Direct Navigator, up to 99 programs can be displayed. With Play List, up to 99 titles (999 scenes) can be displayed.
- While DVD MAIN MENU is displayed, Direct Navigator and Play List display will not appear even if TITLE or MENU is pressed.
- When appears on the screen while a button is being operated, it means that the corresponding operation is prohibited by DECK or the disc.

DVD Operation using On-Screen Displays

When **DISPLAY** is pressed, On-Screen Displays show disc information (title/chapter/track number, elapsed playing time) and DECK information (repeat play, play mode).



Ready Checklist

- DECK is in DVD mode, press DVD.

1 Press **DISPLAY*** in Play or Stop mode to display "On-Screen Displays."

- Each **press** of **DISPLAY** changes the on-screen display as follows. (Refer to pp. 44 ~ 48.)

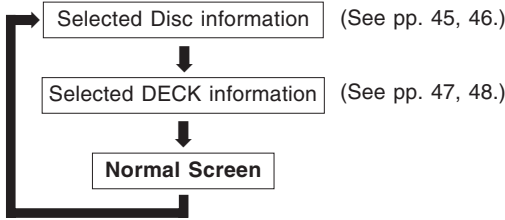

Note

- **DISPLAY** button does not function while main menu of DVD, title menu of DVD, Direct Navigator or Play List is displayed.

2 Press **▲▼** (or **◀▶**) to select an item, and press **SET**.

3 Press **▲▼** or **NUMBER** keys to select the setting, and press **SET**.

<Example of DVD-Video>

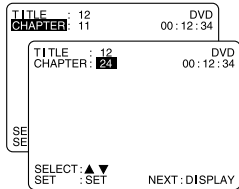

- When numbers are displayed (e.g. title number), **NUMBER** keys are also available.
- If the number entered is not on the disc, the entry will have no effect. Re-enter the correct number.

<Example of DVD-RAM>

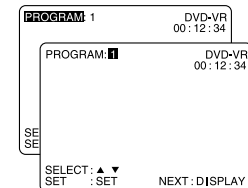

- For more details, refer to the disc operation information.

To return to normal screen, press DISPLAY repeatedly.

Note

- When appears on the screen while a button is being operated, it means that the corresponding operation is prohibited by DECK or the disc.

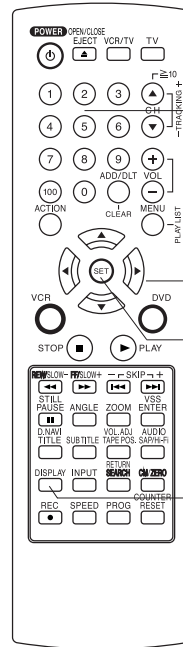

NUMBER keys

SELECT ▲▼◀▶

SET

DISPLAY

*Important: if a remote control button does not work when pressed, press the DVD button on the remote and try the button again.

Detailed Descriptions of each On-Screen Display

■ Disc information screen (for DVD-Video)

1. TITLE No.

Go directly to a preset title number.

- Select "TITLE", and **press SET**.
- Change the No. by **pressing ▲▼** or **NUMBER keys**, and **press SET**.

2. CHAPTER No.

Go directly to a preset chapter number.

- Select "CHAPTER", and **press SET**.
- Change the No. by **pressing ▲▼** or **NUMBER keys**, and **press SET**.
- This function does not work with some discs.

3. Disc currently being played

The type of disc currently inserted is displayed.

4. Elapsed playing time

The screen may be changed by selecting the elapsed time.

- Select the elapsed playing time ("xx:xx:xx"), and **press SET**.
- Change the elapsed time by **pressing NUMBER keys**.

Enter time starting with seconds.

If the time entered is not on the disc, the entry will have no effect.

Re-enter the correct time.

e.g., press 0 → 1 → 2 → 3 → 4 → 5 → SET for "01 : 23 : 45".

press 3 → 0 → SET for "00 : 00 : 30".

- This function does not work with some discs.

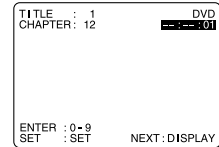
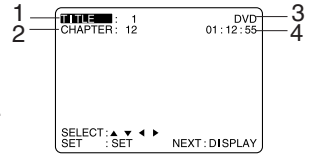

■ Disc information screen (for CD)

A. TRACK No.

Go directly to a preset track number.

- Select "TRACK", and **press SET**.
- Change the No. by **pressing ▲▼** or **NUMBER keys**, and **press SET**.

B. Disc currently being played

The type of disc currently inserted is displayed.

C. Elapsed playing time

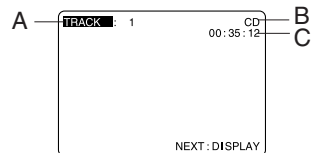

DVD Operation using On-Screen Displays (continued)

■ Disc information screen (for DVD-RAM)

1. Direct Navigation (PROGRAM) or PLAY LIST No.

Go directly to a preset title number.

- Select "PROGRAM" or "PLAY LIST", and **press SET**.
- Change the No. by **pressing ▲▼** or **NUMBER keys**, and **press SET**.

2. Disc currently being played

The type of disc currently inserted is displayed.

3. Elapsed playing time

The screen may be changed by selecting the elapsed time.

- Select the elapsed playing time ("xx:xx:xx"), and **press SET**.
- Change the elapsed time by **pressing NUMBER keys**.

Enter time starting with seconds.

If the time entered is not on the disc, the entry will have no effect.
Re-enter the correct time.

e.g., press 0 → 1 → 2 → 3 → 4 → 5 → SET for "01 : 23 : 45".
press 3 → 0 → SET for "00 : 00 : 30".

- This function does not work with some discs.

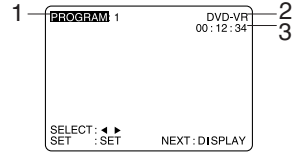

Direct Navigation
(PROGRAM)

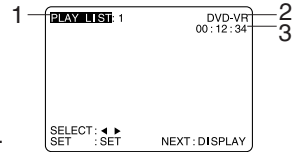

PLAY LIST

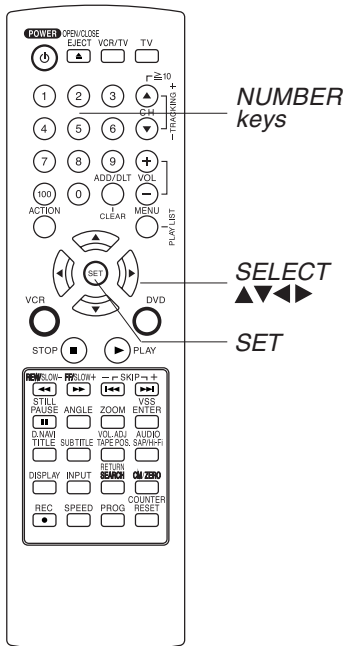
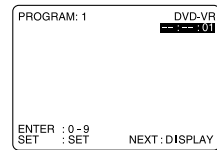

Note

- When  appears on the screen while a button is being operated, it means that the corresponding operation is prohibited by DECK or the disc.

*Important: if a remote control button does not work when pressed, press the DVD button on the remote and try the button again.

■ DECK information screen (for DECK)

1. Operating mode

The current operation is displayed.

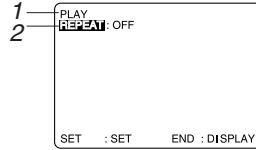

2. Repeat Play mode (see p. 48)

Repeat play mode can be selected.

- Select "REPEAT", and **press SET**.
- Change the desired mode during play by **pressing ▲▼**, and **press SET**.

		Repeat Play mode		
DVD-Video		CHAPTER	TITLE	OFF (NORMAL)
DVD-RAM	(PROGRAM)	PROGRAM	DISC	OFF (NORMAL)
	(PLAY LIST)	PLAY LIST	ALL PLAY LIST	OFF (NORMAL)
CD		TRACK	DISC	OFF (NORMAL)

3. Play mode [CD only] (See p. 39, 40.)

When Play mode is set (p. 39, 40), the mode name is displayed.

PROGRAM PLAY	program play
RANDOM PLAY	random play
----	normal play

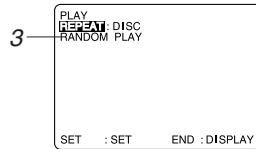

Note • For repeat play in VCR mode, see p. 31.

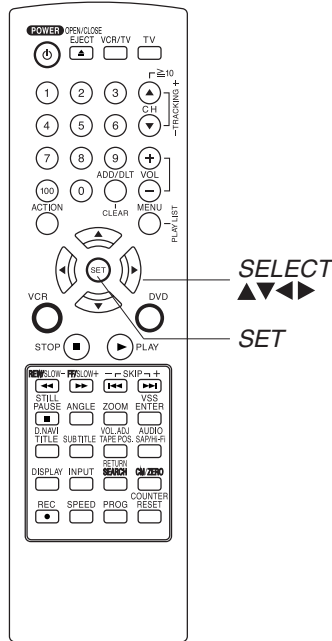

DVD Operation using On-Screen Displays (continued)

For your reference

Repeat Play mode example (see p. 47)

• CHAPTER/TITLE REPEAT PLAY (DVD-Video)

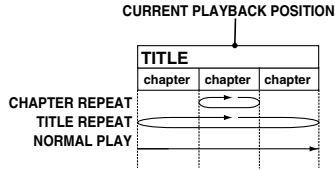

• TRACK/DISC REPEAT PLAY (CD)

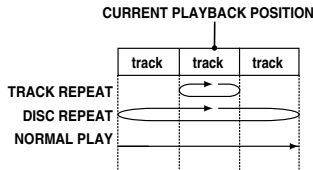

• PROGRAM/DISC REPEAT PLAY (DVD-RAM [PROGRAM])

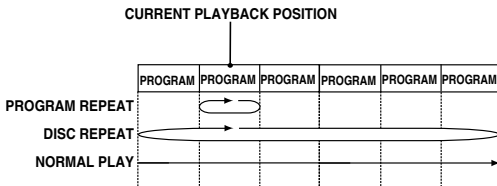

• PLAY LIST/ALL PLAY LIST REPEAT PLAY (DVD-RAM [PLAY LIST])

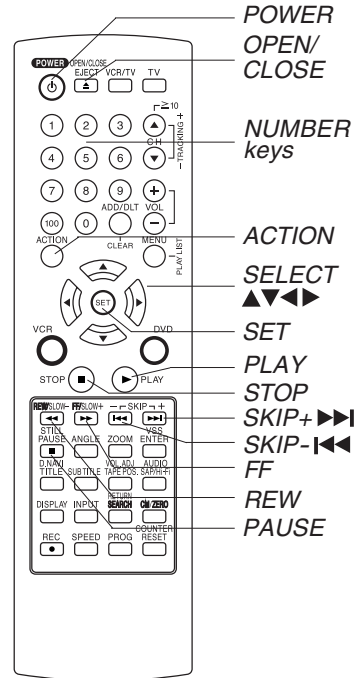
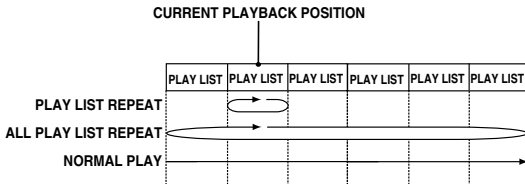

Note • For repeat play in VCR mode, see p. 31.

*Important: if a remote control button does not work when pressed, press the DVD button on the remote and try the button again.

MP3/JPEG Playback Operation

This unit can play MP3/JPEG format CD-R or CD-RW recorded for personal use on a PC, etc. Some discs may not play due to the condition of the recording.

1 Press **POWER*** on the remote or DECK.

2 Press **OPEN/CLOSE**, then place an MP3/JPEG disc into the disc tray.
Press **OPEN/CLOSE** to close.

3 • MP3/JPEG MENU is displayed.
• Playback starts automatically (except JPEG files).
• CD directory is displayed.

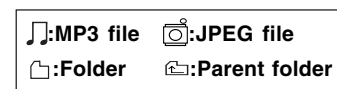
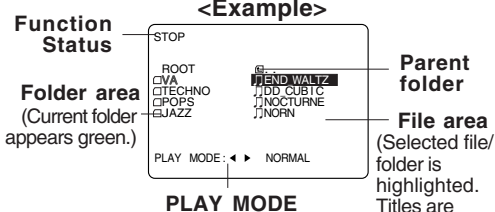

<Example> (Diagram left shows CD directory structure as displayed in example OSD above.)

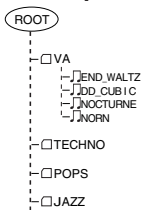

Notes

- Only File (not Folder) area operation is possible.
- Files are displayed in the following order: (!...0,1...9,A,B.....Z).

4 • **Select file** (During STOP mode)
1) Press **▲▼** to select an MP3 file (🎵).
➔ MP3 Playback (see right)
2) Press **▲▼** to select a JPEG file (📷).
➔ JPEG Playback (see p. 50)
3) Press **SKIP+ ▶▶|** (next) or **SKIP- |◀◀** (previous) to skip a file/folder page (7 files) in the File area.
• **Select folder** (During STOP mode)
1) Press **▲▼** to select a folder (📁).
2) Press **SET** to display files/folders contained in the folder.
• **Select parent folder** (During STOP mode)
1) Press **▲▼** to select a folder (📁).
2) Press **SET** to make changes to the previous directory display.

5 Press **ACTION** to return the DVD MAIN MENU. (➔ Press **ACTION** again to return to the MP3/JPEG MENU.)

MP3 Playback

Do steps 1~3 at left.

a Press **▲▼** to select an MP3 file (🎵).
(During STOP mode)

b Press **SET** or **PLAY** to start playback.

Forward/Reverse Search

Press **FF/SLOW+** or **REW/SLOW-** during play.
Press **PLAY** to release.

- Search speed, slow at first, increases with each additional press of the button up to 5 levels.

Forward/Reverse Track Skip

Press **SKIP+ ▶▶|** or **SKIP- |◀◀** during play.
Each press skips a track.

- If pressed within first 3 seconds of playback, skips to the previous track. If over 3 seconds, returns to top of track. (**SKIP- |◀◀** only.)

- Put DECK in Stop mode before performing folder/file selection (see step 4.)

Pause

Press **PAUSE** during play.
Press **PLAY** to release.

c Press **STOP** to stop play.

d Press **OPEN/CLOSE** to eject the disc.
The MP3/JPEG MENU is closed automatically.

Note

- Copyright protected files and files containing errors cannot be played back. The DECK skips to the next file.

■ **Select PLAY MODE [MP3 Playback]**
(During STOP mode)

Press **◀▶** to select the desired PLAY MODE (see below).

[PLAY MODE]

NORMAL:

All MP3 files are selected and played back one time only.

SINGLE REPEAT:

The selected MP3 file is played back repeatedly.

FOLDER REPEAT:

The MP3 files contained in the selected folder are played back repeatedly. However, folders below the selected folder are not played back.

DISC REPEAT:

All MP3 files are played back repeatedly.

MP3/JPEG Playback Operation (continued)

JPEG Playback

You can play back JPEG images.

Displayable Image Size: 32x32~7680x7680 pixels

Note • Some JPEG format may not be played back.

Do steps 1~3 on page 49.

1 Press **▲▼** to select a JPEG file (📷).

2 Press **SET** or **PLAY**.
Selected JPEG file is displayed.
[JPEG Playback Screen]

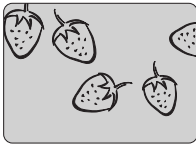

<Example>

- Returned on the MP3/JPEG MENU
⇒ Press **STOP**. (See p. 49)
- Next/Previous Search
⇒ Press **SKIP+** ▶▶| or **SKIP-** |◀◀.
- Start Slide-show ⇒ Press **FF/SLOW+** or **REW/SLOW-**. (below)
- Enlarging an image ⇒ Press **ZOOM**. (P. 51)
- Rotating an image ⇒ Press **ANGLE**. (P. 51)

3 Press **STOP** to return to the MP3/JPEG MENU.

JPEG Slide-show

(During JPEG Playback.)
JPEG files are displayed automatically (about every 3 seconds) as a slide-show.

1 Press **FF/SLOW+** or **REW/SLOW-**.

<Example>



Image changes every 3 seconds.

- Cancel slide show
⇒ Press **STOP** to return the MP3/JPEG MENU. (See p. 49)
- Still picture
⇒ Press **STILL** (only SLIDE).
⇒ Press **PLAY** to release.
- Forward/Reverse File Skip
⇒ Press **SKIP+** ▶▶| or **SKIP-** |◀◀.
Each press skips a file.

2 Press **ACTION** to return to the DVD MAIN MENU.

- Select **PLAY MODE [JPEG Slide-show]** (During STOP mode)
Press **◀▶** to select the desired **PLAY MODE** (See below).

[PLAY MODE]

NORMAL: All JPEG files are selected and played back one time only.
SINGLE REPEAT: The selected JPEG file is played back repeatedly.
FOLDER REPEAT: The JPEG files contained in the selected folder are played back repeatedly. However, folders below the selected folder are not played back.
DISC REPEAT: All JPEG files are played back repeatedly.

<Example>

Operation can be done when files are in order, such as in the diagram below.

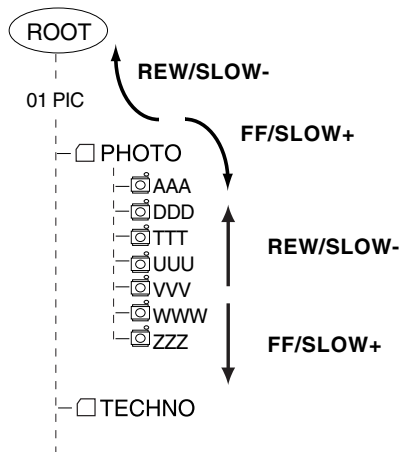

JPEG Zoom

(During JPEG Playback.)

You can enlarge specific portions of a JPEG picture and select the zoom ratio using the ZOOM button on the remote during JPEG Playback screen.

Set Zoom size.

Press **ZOOM** repeatedly to change display as follows.

⇒ Press **STOP** to return the MP3/JPEG MENU.

- You can enlarge the center portion of the image to one of 2 magnifications.
- Operation can be done during Rotation (below).

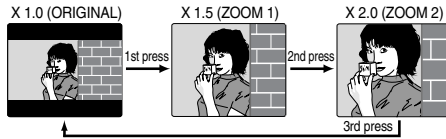

- Use the **▲**, **▼**, **◀** and **▶** buttons to move the position up, down, left and right. (Position cannot be changed on X1.0 ORIGINAL images.)

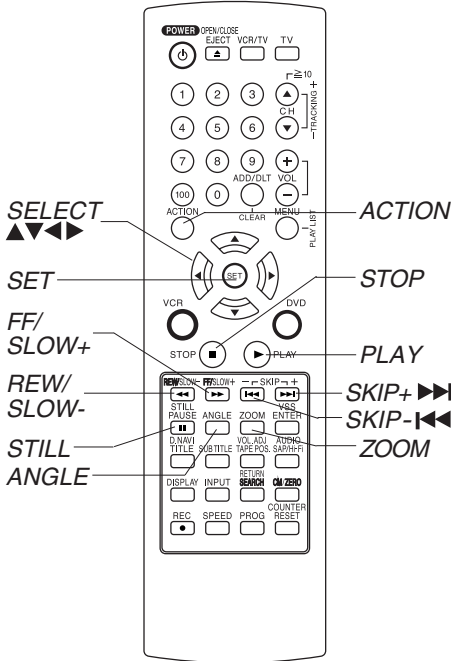

JPEG Rotation

(During JPEG Playback.)

You can rotate a JPEG picture using the ANGLE button on the remote during JPEG Playback screen. (The JPEG picture will be rotated 90 ° clockwise.)

Set rotation.

Press **ANGLE** repeatedly to change display as below.

⇒ Press **STOP** to return the MP3/JPEG MENU.

- Operation can be done during Zoom (above).
- The vertical/horizontal ratio of rotated JPEG images may vary when they are displayed.

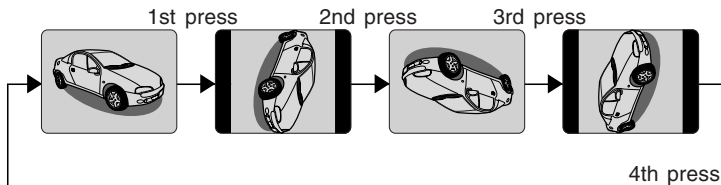

MPEG Layer-3 audio decoding technology licensed from Fraunhofer IIS and Thomson multimedia.

MP3
PLAYBACK

Settings for DVD Operation

1 Press **ACTION*** to display DVD MAIN MENU.



Press **▲▼** to select an item, and press **SET**.

DISC LANGUAGES (See below)

All languages offered on the disc can be set. If a language not offered is set, the original disc language will be selected.

AUDIO OUTPUT (See p. 53.)

You can set the audio output that comes from the digital audio output terminal.

STILL MODE (See p. 54.)

To select "FIELD" (Field still) or "FRAME" (Frame still) to prevent jitter or make small text or fine patterns clearly visible in a still picture. When "AUTO" is set, "FIELD" or "FRAME" is selected automatically.

TV MODE (See p. 54.)

To select whether the video material for a wide-screen will be played back in the Pan & Scan style, Letterbox style or 16 : 9 style.

Disc Languages (DVD only)

To select and set the language of the audio soundtrack, subtitles, or title/DVD menus for all discs to be played.



Press **▲▼** to select "DISC LANGUAGES," and press **SET** to display screen.

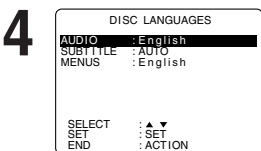

Press **▲▼** to select an item, and press **SET** repeatedly for desired language. (Please refer right.)

5 Press **ACTION** to redisplay DVD MAIN MENU and go to step 2 to setup another item.

Or, press **ACTION** twice to exit.

Once initial settings are done, they remain in memory (even after power is turned off) until changed. This means DECK will operate under the same conditions (especially DVDs) each time.



Ready Checklist

DECK is in DVD mode, press DVD.

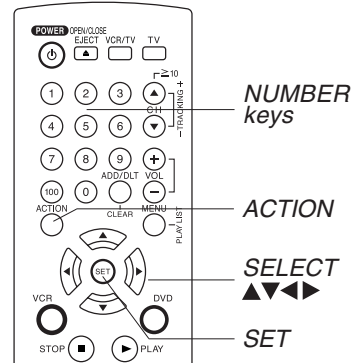

"AUDIO" selections

(Factory preset: English)

To select the audio soundtrack language.

English/Spanish/French/Japanese

Original: Original disc language

OTHER 0000: Other language selection*1

"SUBTITLE" selections

(Factory preset: AUTO)

To select the subtitle language.

AUTO: Same language selected for "AUDIO"

• If language set for "AUDIO" is used in

playback, subtitles will not appear.

• If another language is used during playback, the subtitles will appear in the language selected at "AUDIO" setup.

English/Spanish/French/Japanese

OTHER 0000: Other language selection*1

"MENU" selections

(factory preset: English)

To select the language used in title menus or DVD menus.

English/Spanish/French/Japanese

OTHER 0000: Other language selection*1

To enter OTHER **** code number,

Press **NUMBER** keys (Please refer to language codes on p. 56).

To make corrections, press **◀** repeatedly to delete language code number, and correct.

*1 If the selected language is not offered, the original disc language is selected.

***Important:** If a remote control button does not work when pressed, press the DVD button on the remote and try the button again.

Audio Output (DVD only)

Select the digital output to be output from the optical digital audio output connector of DECK.

1 Press ACTION to display DVD MAIN MENU.



Press **▲▼** to select "AUDIO OUTPUT," and press **SET** to display screen.

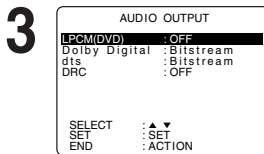

Press **▲▼** to select an item, and press **SET** repeatedly for output. (See below.)

■ "LPCM (DVD)" selections

OFF: Linear PCM of less than 48 kHz/16 bit is output. When playing DVDs recorded in linear PCM of over 48 kHz/20 bit, no digital audio is output. (Factory preset)

PCM: When playing DVDs recorded in linear PCM of 48 kHz/20 bit/24 bit or more, digital audio converted to 48 kHz/16 bit is output. (Digital output of PCM audio is restricted to 48 kHz/16 bit or below for copyright protection.)

■ "Dolby Digital" selections

Bitstream: Dolby Digital bitstream (1 ch - 5.1 ch) is output. (Factory preset)

PCM: When you have connected an amplifier that doesn't have a built-in Dolby Digital decoder.

■ "dts" selections

Bitstream: DTS bitstream is output. (Factory preset)

PCM: When you have connected an amplifier that doesn't have a built-in DTS decoder.

■ "DRC (Dynamic Range Compression)" selections

OFF: Normal audio range is selected. (Factory preset)

ON: For dynamic sound even at low volume, this is useful for late-night listening. [Dolby Digital DVDs only].

4 Press ACTION to redisplay DVD MAIN MENU and go to step 2 to setup another item.

Or, press **ACTION** twice to exit.



Ready Checklist

DECK is in DVD mode, press DVD.

Type of amplifier to be connected	Recommended setting		
	LPCM (DVD)	Dolby Digital	DTS
No amplifier is connected	---	---	---
AV amplifier (with digital audio input connector) without Dolby Digital/DTS decoder	PCM	PCM*1	PCM*1
AV amplifier including Dolby Digital decoder	PCM	Bitstream	PCM
AV amplifier including Dolby Digital/DTS decoder	PCM	Bitstream	Bitstream*2

• Make settings according to amplifier connected to optical audio output as shown in above table.

*1 When connecting an amplifier (with an optical digital input connector) which does not contain the Dolby Digital or DTS decoder, be sure to select "PCM". If "Bitstream" is selected, starting DVD play may cause such a high level of noise as to be harmful to your ears and damage the speakers.

*2 When a dts decoder is connected, please select "Bitstream" in "dts." If "PCM" is selected, there will be stereo sound. When a Dolby Digital decoder is connected, please select "Bitstream" in "Dolby Digital." If "PCM" is selected, there will be stereo sound.

Settings for DVD Operation (continued)

Still Mode (DVD only)

Set to reduce jitter in a displayed still picture or a motion picture.

1 Press **ACTION*** to display DVD MAIN MENU.

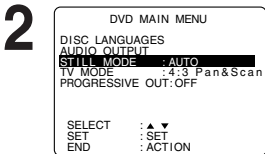

Press **▲▼** to select "STILL MODE," and press **SET** repeatedly for mode. (See below.)

AUTO: "FIELD" (Field still) or "FRAME" (Frame still) is automatically selected during the still mode. (Factory preset)

FIELD: "FIELD" (Field still) is always selected. This setting will reduce jitter when compared with "AUTO" on some discs.

FRAME: "FRAME" (Frame still) is always selected. Some texts and fine patterns will be seen clearly when compared with "AUTO" on some discs.

3 Press **ACTION** to exit this mode.

TV Mode (DVD only)

Set the screen display style for wide-screen video material playback.

1 Press **ACTION** to display DVD MAIN MENU.

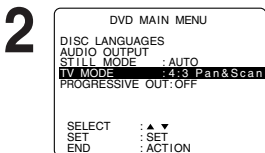

Press **▲▼** to select "TV MODE," and press **SET** repeatedly for mode. (See below.)

4:3 Pan & Scan (Factory preset) :
Wide-screen video data is played in Pan & Scan style (left and right of screen is trimmed.)
• Video data not formatted in Pan & Scan will play in letterbox style.

4:3 Letterbox :
Wide-screen video data is played in Letterbox style (top and bottom of screen has black margin).

16:9 :
Set "16:9" when using Wide-screen TV.

3 Press **ACTION** to exit this mode.

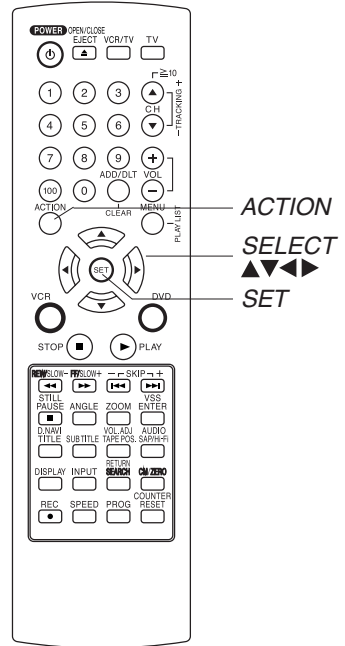

Example

- Pan & Scan (Factory preset)

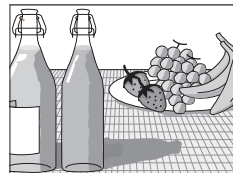

- Letterbox



***Important:** If a remote control button does not work when pressed, press the DVD button on the remote and try the button again.

PROGRESSIVE OUT

Sets the Component Video Output Connector (p. 10, 13) to output the Progressive scan signal.

1 Press **ACTION** to display DVD MAIN MENU.



Press **▲▼** to select “PROGRESSIVE OUT,” and press **SET** repeatedly for mode. (See below.)

OFF: Progressive scan signal is not output.

ON: Progressive scan signal is output from the Component Video Output Connector.

3 Press **ACTION** to exit this mode.

Notes

- If the television is not progressive compatible, a progressive scan picture is not available. Connect the Video Output or S-Video Output connector (see p. 12, 13) and set PROGRESSIVE OUT to “OFF”.
- CONSUMERS SHOULD NOTE THAT NOT ALL HIGH DEFINITION TELEVISION SETS ARE FULLY COMPATIBLE WITH THIS PRODUCT AND MAY CAUSE ARTIFACTS TO BE DISPLAYED IN THE PICTURE. IN CASE OF 525 PROGRESSIVE SCAN PICTURE PROBLEMS, IT IS RECOMMENDED TO SET PROGRESSIVE OUT TO “OFF”. IF THERE ARE QUESTIONS REGARDING OUR TV SET COMPATIBILITY WITH THIS MODEL 525p DVD/VCR DECK, PLEASE CONTACT OUR CUSTOMER SERVICE CENTER.

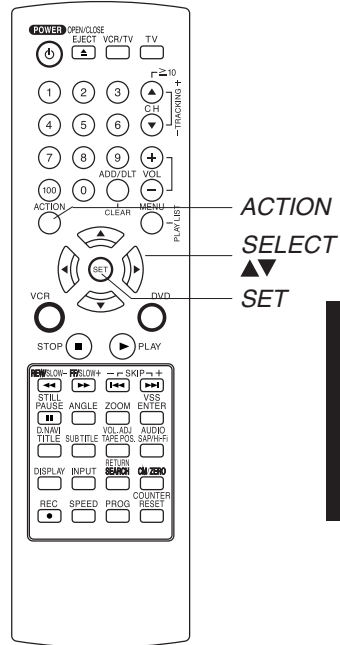

DVD
Operation

Language Code List

Enter the appropriate code number for the initial settings "AUDIO", "SUBTITLE" and/or "MENU" (see p. 52).

Code	Language	Code	Language	Code	Language	Code	Language
6565	Afar	7079	Faroese	7678	Lingala	8375	Slovak
6566	Abkhazian	7082	French	7679	Laothian	8376	Slovenian
6570	Afrikaans	7089	Frisian	7684	Lithuanian	8377	Samoaan
6577	Ameharic	7165	Irish	7686	Latvian, Lettish	8378	Shona
6582	Arabic	7168	Scots Gaelic	7771	Malagasy	8379	Somali
6583	Assamese	7176	Galician	7773	Maori	8381	Albanian
6588	Aymara	7178	Guarani	7775	Macedonian	8382	Serbian
6590	Azerbaijani	7185	Gujarati	7776	Malayalam	8385	Sundanese
6665	Bashkir	7265	Hausa	7778	Mongolian	8386	Swedish
6669	Byelorussian	7273	Hindi	7779	Moldavian	8387	Swahili
6671	Bulgarian	7282	Croatian	7782	Marathi	8465	Tamil
6672	Bihari	7285	Hungarian	7783	Malay	8469	Telugu
6678	Bengali; Bangla	7289	Armenian	7784	Maltese	8471	Tajik
6679	Tibetan	7365	Interlingua	7789	Burmese	8472	Thai
6682	Breton	7378	Indonesian	7865	Nauru	8473	Tigrinya
6765	Catalan	7383	Icelandic	7869	Nepali	8475	Turkmen
6779	Corsican	7384	Italian	7876	Dutch	8476	Tagalog
6783	Czech	7387	Hebrew	7879	Norwegian	8479	Tonga
6789	Welsh	7465	Japanese	7982	Oriya	8482	Turkish
6865	Danish	7473	Yiddish	8065	Panjabi	8484	Tatar
6869	German	7487	Javanese	8076	Polish	8487	Twi
6890	Bhutani	7565	Georgian	8083	Pashto, Pushto	8575	Ukrainian
6976	Greek	7575	Kazakh	8084	Portuguese	8582	Urdu
6978	English	7576	Greenlandic	8185	Quechua	8590	Uzbek
6979	Esperanto	7577	Cambodian	8277	Rhaeto-Romance	8673	Vietnamese
6983	Spanish	7578	Kannada	8279	Romanian	8679	Volapük
6984	Estonian	7579	Korean	8285	Russian	8779	Wolof
6985	Basque	7583	Kashmiri	8365	Sanskrit	8872	Xhosa
7065	Persian	7585	Kurdish	8368	Sindhi	8979	Yoruba
7073	Finnish	7589	Kirghiz	8372	Serbo-Croatian	9072	Chinese
7074	Fiji	7665	Latin	8373	Singhalese	9085	Zulu

Warning and Instruction Displays

These displays will alert you to a missed operation or provide further instructions.

OSD	Caution	Page
PLEASE SET CLOCK BY PRESSING ACTION KEY	If you attempt to set or review a Timer Recording and the Clock is not set...	24
PLEASE PREPARE FOR TIMER REC	If the DECK is not in Stop mode, or cassette is not inserted, or cassette has no record tab, or tape is at its end 2 minutes before a Timer Recording is about to begin...	24 25
CHECK CASSETTE RECORD TAB	If you press REC on the remote control or DECK, and a cassette is inserted with no record tab...	6
NO CASSETTE	If you press PLAY, FF, REW, or REC on the remote control or DECK without a cassette inserted...	20 21
TO CANCEL TIMER REC HOLD DOWN STOP KEY FOR APPROX 3 SEC	If you press STOP or POWER during a Timer Recording... (visible in VCR mode only)	25
VIDEO HEADS MAY NEED CLEANING PLEASE INSERT HEAD CLEANING CASSETTE OR REFER TO MANUAL END : PLAY	If head cleaning becomes necessary while playing back a tape...	4
VCR LOCK ACTIVATED	If you press a function button other than STOP/EJECT or POWER while DECK is in VCR Lock mode...	32
REMOTE CONTROL IS SET TO TV MODE USE VCR : VCR KEY USE DVD : DVD KEY	If you press an invalid key on the remote while in TV mode...	28 29 34
PLEASE CHECK THE DISC, AND FOR STAINS OR SCRATCHES ON DISC	If you press PLAY, and DECK reads data from a stained or scratched disc in DVD mode.	6
THIS DISC MAY NOT BE PLAYED IN YOUR REGION	Playback of a disc with different region number was attempted. Only discs marked region "1", "ALL", or those that include "1" are playable on this DECK.	3
THIS TYPE OF DISC CANNOT BE PLAYED. PLEASE INSERT A DIFFERENT DISC	An unusable disc is inserted in the unit, or the disc is not installed with label side up.	6
CANNOT PLAY THIS FILE	This file format cannot be played. (Appears during MP3/JPEG file playback)	49

Before Requesting Service

Check the following points if you are having trouble with your DECK.

Power	Solution
No power...	<ul style="list-style-type: none"> • Completely insert Power Plug into an AC outlet. • Press POWER button on. • Make sure power source is active.
Power turns itself off...	<ul style="list-style-type: none"> • Auto power-off (shutoff) occurs after about 5 min. in DVD mode with no operation, or if there is no broadcast signal in TV or Playback mode. Turn the power back on. (pp. 23, 33)
Recording & Playback	Solution
TV program cannot be recorded...	<ul style="list-style-type: none"> • Check connections between DECK, external antenna, and TV. • Check channel selections. • Make sure your antenna system (CABLE or TV) is correctly set. (Channels [p. 18]) • Make sure cassette record tab is intact. (p. 6)
Timer recording cannot be performed...	<ul style="list-style-type: none"> • Confirm that clock is set to current time and date. • Make sure Cable/DSS box (if used) is left on and tuned to channel to be recorded. • Set recording start/stop times correctly. (p. 24) • Timer recording may not be performed or continued if a power interruption occurs before or during a Timer Recording, even after power is restored.
There is no playback picture, or the playback picture is noisy or contains streaks...	<ul style="list-style-type: none"> • Select channel 3 or 4 on TV to match VCR output channel (3 or 4) (p. 16) or select LINE. • Set VCR/TV selector to "VCR." • Adjust TRACKING control in either direction. (p. 4) • Try Head Cleaning. (p. 4)
During special effects playback picture may contain some vertical jitter when using a TV with an Automatic Vertical Hold Control...	<ul style="list-style-type: none"> • Set TV's Vertical Hold Control to MANUAL, then adjust.
DECK cannot be controlled...	<ul style="list-style-type: none"> • Make sure DECK power is on. • Check Remote batteries. • Make sure VCR LOCK is set to off. (p. 32) • Make sure Remote is in proper mode. (p. 28) • Make sure Timer Recording is not in progress.
Remote Control	Solution
DECK cannot be remote controlled...	<ul style="list-style-type: none"> • Make sure DECK power is on. • Make sure Remote is in VCR mode. • Aim Remote Control directly at remote sensor on DECK. (p.9) • Avoid any object blocking signal path. • Check Remote batteries. (p. 4) • Exposing DECK remote sensor to direct fluorescent or outdoor light may cause signal interference.
PROG buttons do not respond...	<ul style="list-style-type: none"> • PROG functions are not available in COMPONENT Video Output and S-VIDEO OUT. Set TV to either RF IN or VIDEO IN. (p. 10) • Check Remote batteries. (p. 4) • Press VCR or DVD button for DVD/VCR mode. (p. 28)

DVD/CD	Solution
Play fails to start even when PLAY is pressed...	<ul style="list-style-type: none"> This DECK cannot play discs other than DVDs and CDs. The disc may be dirty and require cleaning.
Picture is distorted during rapid advance or rapid reverse...	<ul style="list-style-type: none"> The picture will be somewhat distorted at times: this is normal.
No Forward/Reverse Scene Search play...	<ul style="list-style-type: none"> Some discs may have sections which prohibit Forward/Reverse Scene Search. (p. 23)
Audio soundtrack and/or subtitle language is not the one selected at the initial settings...	<ul style="list-style-type: none"> If the audio soundtrack and/or subtitle language selected at DVD initial settings does not exist on the disc, it will not be accessible.
No subtitles...	<ul style="list-style-type: none"> Subtitles appear only when available on disc. "OFF" is selected at the changing subtitle language. Select "ON" at the "Subtitle Languages" section (p. 36) to display the subtitles.
Alternative audio soundtrack (or subtitle) language cannot be selected...	<ul style="list-style-type: none"> Alternative language cannot be selected with discs which do not contain more than one language. For some discs, alternative language cannot be selected with the AUDIO or SUB TITLE button. Try selecting it from the DVD MAIN MENU if available.
Angle cannot be changed...	<ul style="list-style-type: none"> This function is dependent on software availability. Even if disc has multiple angles, they may be recorded for specific scenes only (ANGLE indicator on DECK lights up). (p. 37)
Miscellaneous	Solution
Programs cannot be viewed on TV...	<ul style="list-style-type: none"> Make sure TV is tuned to VCR's output channel (3 or 4). Check connections between DECK, external antenna, and TV. Set VCR/TV selector to "TV." (p. 21) Make sure proper signal source is selected. If the television is not progressive compatible, a progressive scan picture is not available. Connect the Video Output or S-Video Output connector (pp. 12, 13) and set PROGRESSIVE OUT to "OFF" in the DVD Main Menu. (p. 55)
Video cassette cannot be inserted...	<ul style="list-style-type: none"> Insert the cassette with window side up; record tab facing you.
Video cassette ejects when a recording is started or the power is turned off for timer recording...	<ul style="list-style-type: none"> Make sure cassette record tab is intact. (p. 6)
In Stop mode, the motor (CYLINDER) continues to rotate...	<ul style="list-style-type: none"> To enable Quick play mechanism, the cylinder will rotate for about 3 minutes. This reduces response time from Stop to Play mode.
The disc cannot be removed..	<ul style="list-style-type: none"> First, unplug DECK. Then, prepare a rigid wire (e.g. an extended paper clip) and, applying moderate force, insert it straight into the hole at the base of the tray. The tray will eject a little. Now, pull the tray all the way out and remove the disc. (p. 9)

If you cannot resolve the problem, please call the Customer Call Center for product assistance at 1-800-211-PANA (7262).

To locate an authorized servicenter, please call toll free 1-800-211-PANA (7262). or, contact us via the web at: <http://www.panasonic.com/contactinfo>

Limited Warranty

PANASONIC CONSUMER ELECTRONICS COMPANY,
DIVISION OF MATSUSHITA ELECTRIC
CORPORATION OF AMERICA
One Panasonic Way
Secaucus, New Jersey 07094

PANASONIC SALES COMPANY,
DIVISION OF MATSUSHITA
ELECTRIC OF PUERTO RICO, INC.,
AVE. 65 de Infantería, Km. 9.5
San Gabriel Industrial Park
Carolina, Puerto Rico 00985

Panasonic DVD/VCR Deck Limited Warranty

Limited Warranty Coverage

If your product does not work properly because of a defect in materials or workmanship, Panasonic Consumer Electronics Company or Panasonic Sales Company (collectively referred to as "the warrantor") will, for the length of the period indicated on the chart below, which starts with the date of original purchase ("Limited Warranty period"), at its option either (a) repair your product with new or refurbished parts, or (b) replace it with a new or a refurbished product. The decision to repair or replace will be made by the warrantor.

Product or Part Name	Parts	Labor
DVD/VCR Deck	One (1) Year	Ninety (90) Days
Rechargeable Batteries (in exchange for defective item)	Ten (10) Days	Not Applicable

During the "Labor" Limited Warranty period there will be no charge for labor. During the "Parts" warranty period, there will be no charge for parts. You must mail-in your product during the warranty period. If non-rechargeable batteries are included, they are not warranted. This Limited Warranty only applies to products purchased and serviced in the United States or Puerto Rico. This Limited Warranty is extended only to the original purchaser and only covers product purchased as new. A purchase receipt or other proof of original purchase date is required for Limited Warranty service.

Mail-In Service

For assistance in the continental U.S.A. in obtaining repairs please ship the product to:

Panasonic Services Company
Customer Servicenter
Suite B
4900 George McVay Drive
McAllen, TX 78503

For assistance in Puerto Rico call Panasonic Sales Company (787)-750-4300 or fax (787)-768-2910.

When shipping the unit carefully pack and send it prepaid, adequately insured and preferably in the original carton. Include a letter detailing the complaint and provide a day time phone number where you can be reached.

IF REPAIR IS NEEDED DURING THE LIMITED WARRANTY PERIOD THE PURCHASER WILL BE REQUIRED TO FURNISH A SALES RECEIPT/PROOF OF PURCHASE INDICATING DATE OF PURCHASE, AMOUNT PAID AND PLACE OF PURCHASE. CUSTOMER WILL BE CHARGED FOR THE REPAIR OF ANY UNIT RECEIVED WITHOUT SUCH PROOF OF PURCHASE.

Limited Warranty Limits And Exclusions

This Limited Warranty ONLY COVERS failures due to defects in materials or workmanship, and DOES NOT COVER normal wear and tear or cosmetic damage. The Limited Warranty ALSO DOES NOT COVER damages which occurred in shipment, or failures which are caused by products not supplied by the warrantor, or failures which result from accidents, misuse, abuse, neglect, mishandling, misapplication, alteration, faulty installation, set-up adjustments, misadjustment of consumer controls, improper maintenance, power line surge, lightning damage, modification, or commercial use (such as hotel, office, restaurant, or other business), rental use of the product, or service by anyone other than a Factory Servicenter or other Authorized Servicer, or damage that is attributable to acts of God.

THERE ARE NO EXPRESS WARRANTIES EXCEPT AS LISTED UNDER "LIMITED WARRANTY COVERAGE". THE WARRANTOR IS NOT LIABLE FOR INCIDENTAL OR CONSEQUENTIAL DAMAGES RESULTING FROM THE USE OF THIS PRODUCT, OR ARISING OUT OF ANY BREACH OF THIS WARRANTY. (As examples, this excludes damages for lost time, cost of having someone remove or re-install an installed unit if applicable, travel to and from the servicer, loss of or damage to media or images, data or other recorded content. The items listed are not exclusive, but are for illustration only.) **ALL EXPRESS AND IMPLIED WARRANTIES, INCLUDING THE WARRANTY OF MERCHANTABILITY, ARE LIMITED TO THE PERIOD OF THE LIMITED WARRANTY.**

Some states do not allow the exclusion or limitation of incidental or consequential damages, or limitations on how long an implied Limited Warranty lasts, so the exclusions may not apply to you.

This Limited Warranty gives you specific legal rights and you may also have other rights which vary from state to state. If a problem with this product develops during or after the Limited Warranty period, you may contact your dealer or Servicenter. If the problem is not handled to your satisfaction, then write to the warrantor's Consumer Affairs Department at the addresses listed for the warrantor.

PARTS AND SERVICE, WHICH ARE NOT COVERED BY THIS LIMITED WARRANTY, ARE YOUR RESPONSIBILITY.

Customer Services Directory

Obtain Product Information and Operating Assistance; locate your nearest Dealer or Servicenter; purchase Parts and Accessories; or make Customer Service and Literature requests by visiting our Web Site at:

<http://www.panasonic.com/support>

or, contact us via the web at:

<http://www.panasonic.com/contactinfo>

You may also contact us directly at:

1-800-211-PANA (7262),

Monday-Friday 9 am-9 pm; Saturday-Sunday 10 am-7 pm, EST.

For hearing or speech impaired TTY users, TTY : 1-877-833-8855

Accessory Purchases

Purchase Parts, Accessories and Instruction Books online for all Panasonic Products by visiting our Web Site at:

<http://www.pasc.panasonic.com>

or, send your request by E-mail to:

npcparts@panasonic.com

You may also contact us directly at:

1-800-332-5368 (Phone) 1-800-237-9080 (Fax Only) (Monday - Friday 9 am to 8 pm, EST.)

Panasonic Services Company

20421 84th Avenue South,

Kent, WA 98032

(We Accept Visa, MasterCard, Discover Card, American Express, and Personal Checks)

For hearing or speech impaired TTY users, TTY : 1-866-605-1277

Service in Puerto Rico

Matsushita Electric of Puerto Rico, Inc. Panasonic Sales Company

Factory Servicenter:

Ave. 65 de Infantería, Km. 9.5, San Gabriel Industrial Park,

Carolina, Puerto Rico 00985

Phone (787)750-4300 Fax (787)768-2910

For Your
Information

Medidas de seguridad y precauciones importantes

⚠️ ADVERTENCIA

PARA REDUCIR EL RIESGO DE GOLPES ELÉCTRICOS, INCENDIOS, HERIDAS O DAÑOS A ESTE PRODUCTO, LEA Y GUARDE TODAS LAS INSTRUCCIONES DE SEGURIDAD Y FUNCIONAMIENTO. TENGA EN CUENTA TODAS LAS ADVERTENCIAS INDICADAS EN EL MANUAL Y EN EL PRODUCTO.

INSTALACIÓN

- PRECAUCIÓN CON LA FUENTE DE ALIMENTACIÓN**
El equipo solo debe hacerse funcionar desde una fuente de alimentación que se indique en la unidad o en este manual. Si fuera necesario, haga revisar la fuente de alimentación de su hogar por parte de la Compañía de Suministro Eléctrico o por parte de su Distribuidor de Productos de Vídeo.
- CONECTOR POLARIZADO O CON TOMA A TIERRA**
Como característica de seguridad, este producto de vídeo viene equipado con un enchufe de cable de alimentación polarizado (solo una pata es más ancha que la otra), o con un enchufe del tipo con toma a tierra de tres patas.

PRECAUCIÓN CON EL ENCHUFE POLARIZADO

Este enchufe sólo entrará en la toma en un sentido. Si no pudiera introducir el enchufe a fondo, intente darle la vuelta. Si aún así no entrara, llame a un técnico electricista para que le instale una toma de red adecuada. No desactive esta función de seguridad manipulando el enchufe de ninguna manera.

PRECAUCIÓN CON ENCHUFES CON TOMA A TIERRA

Este enchufe sólo entrará en una toma con conexión a tierra de tres orificios. Si fuera necesario, que un técnico electricista le instale la toma de red adecuada. No desactive esta función de seguridad manipulando el enchufe de ninguna manera.

3 CABLE DE ALIMENTACIÓN

Asegúrese de que los cables de alimentación son dispuestos de tal forma que no se apoye nada sobre ellos, no ruede nada sobre ellos, o que estén en el paso de tráfico al caminar. Si se utilizara un cable alargador, asegúrese de que también disponga de un enchufe polarizado o con toma a tierra y de que puede conectarse firmemente. Los cables pelados, los enchufes averiados o hilos quebrados constituyen un peligro y deben ser reemplazados por un técnico cualificado del servicio técnico. Las tomas eléctricas de la red general sobrecargadas y los cables de extensión constituyen riesgos de incendio y han de evitarse en lo posible.

4 NO BLOQUEE LOS ORIFICIOS DE VENTILACIÓN

Las aberturas de ventilación del mueble liberan el calor generado durante el funcionamiento de la unidad. Si se bloquearan, el calor acumulado dentro de la unidad podría ocasionar fallos que pueden llevar a riesgos de incendio o daños por calor en las cassettes utilizadas.

5 EVITE UBICACIONES MUY CALIENTES O SOMETIDA A CAMBIOS BRUSCOS DE TEMPERATURA

No coloque la unidad encima o cerca de cualquier tipo de calefactor o regulador, bajo la luz solar directa, dentro de vehículos, etc... No traslade la unidad súbitamente entre sitios con variaciones extremas de temperatura. Si la unidad es llevada bruscamente de un sitio frío a otro cálido, la humedad puede condensarse en la unidad y en la cinta.

6 PARA EVITAR LESIONES PERSONALES

- No coloque equipos no fijados en superficies inclinadas.
- No coloque esta unidad sobre ningún soporte que no esté firme, nivelado y que sea adecuadamente fuerte. La unidad podría caerse y producir graves lesiones a niños o adultos y dañarse la unidad misma.
- La combinación de aparato y carrito debe moverse con cuidado. Las paradas súbitas, una fuerza excesiva ya las superficies irregulares pueden ocasionar el vuelco de la combinación de aparato y carrito.
- Siga atentamente las instrucciones de funcionamiento y utilice los accesorios recomendados por el fabricante al hacer funcionar esta unidad o al conectarla a otros equipos.



INSTALACIÓN DE LA ANTENA EXTERIOR

- CONEXIÓN SEGURA DE LA ANTENA Y DE LOS CABLES**
Si se conectará una antena exterior o sistema de cable conectado al equipo, el usuario deberá asegurarse de que la antena o el sistema de cable disponen de toma a tierra como forma de proporcionar protección contra la acumulación de cargas estáticas y saltos de corrientes. La sección 810 del Código Eléctrico Nacional, ANSI/NFPA 70 (en Canadá, la parte 1 del Código Eléctrico Canadiense) proporciona información con respecto a la conexión a tierra correcta del mástil y la estructura de soporte, conexión a tierra de los cables de bajada de antena a una unidad de descarga, tamaño de los conductores a tierra, ubicación de la unidad de descarga de antena, conexión de los electrodos a tierra y requisitos del electrodo de toma a tierra.
- MANTENGA LA ANTENA LIBRE DE LÍNEAS O CIRCUITOS DE ALTO VOLTAJE**
Un sistema de antena exterior deberá ser colocado bien alejado de líneas de alimentación, luz eléctrica o circuitos de alimentación para que nunca esté en contacto con tales fuentes de alimentación si se cayera. Al instalar una antena exterior, debe tenerse muchísimo cuidado para evitar las líneas de alimentación, circuitos u otras fuentes de alimentación ya que esto podría resultar mortal. Debido a los riesgos implicados en la instalación de una antena, tal operación debe dejarse a un profesional.

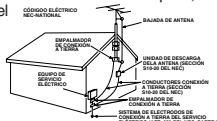

UTILIZACIÓN DE LA UNIDAD DE VÍDEO

Si la unidad ha estado almacenada o es trasladada a una nueva ubicación, remítase primero a la sección de INSTALACIÓN de estas medidas de seguridad.

- MANTENGA ESTA UNIDAD DE VÍDEO ALEJADA DEL AGUA O DE HUMEDAD DE CUALQUIER TIPO**
- SI EL EQUIPO ES EXPUESTO A LA LLUVIA, HUMEDAD, O FUERTES IMPACTOS**, desenchufe la unidad y que sea revisada por un técnico cualificado antes de volver a utilizarla.
- DURANTE UNA TORMENTA ELÉCTRICA**
Durante una tormenta con rayos, tanto en interiores como en el exterior, o antes de dejar la unidad sin utilizar durante largos periodos de tiempo, desconecte todos los equipos de la fuente de alimentación así como la antena y el sistema de cableado.
- AL ENCHUFAR LA UNIDAD**
 - No exponga nunca la unidad a la lluvia o el agua. NO LA HAGA FUNCIONAR si se ha derramado líquido dentro de la unidad. Desenchufe la unidad inmediatamente ya que sea revisada por un técnico. Pueden producirse incendios o sacudidas eléctricas derivadas de cortocircuitos eléctricos causados por el contacto de líquidos con el interior de la unidad.
 - No deje caer ni introduzca ningún objeto por las aberturas de la unidad. Algunas piezas internas tienen un voltaje peligroso y el contacto con ellas puede producir sacudidas eléctricas o incendios.
 - Evite colocar la unidad directamente encima o debajo del televisor, ya que esto podría causar interferencias eléctricas. Mantenga cualquier tipo de imán alejados de equipos electrónicos.
- UTILIZACIÓN DE ACCESORIOS**
Utilice sólo accesorios recomendados por el fabricante para así evitar riesgos de incendio, sacudidas eléctricas y otros peligros.
- LIMPIEZA DE LA UNIDAD**
Desenchufe la unidad. Luego utilice un paño limpio y seco, sin tratamiento químico para quitar suavemente el polvo o suciedad. NO UTILICE productos de limpieza, aerosoles, o aire comprimido que pudieran causar un exceso de pulverización o introducirse en la unidad y ocasionar sacudidas eléctricas. Cualquier substancia, como cera, cinta adhesiva, etc., podría arruinar el acabado de la superficie. La exposición a substancias grasosas, áreas húmedas o polvorientas puede afectar de manera adversa a las piezas internas.

SERVICIO

- EL USUARIO NO DEBE REALIZAR NINGUNA OPERACIÓN DE SERVICIO TÉCNICO POR SÍ MISMO**
Si, después de observar atentamente las detalladas instrucciones de funcionamiento, este producto de vídeo no funcionara correctamente, no intente abrir o extraer las tapas, o realizar cualquier ajuste no indicado en este manual. Desenchufe la unidad y llévela a un técnico cualificado de servicio técnico.
- SI FUERAN NECESARIAS PIEZAS DE RECAMBIO**
Asegúrese de que el técnico de servicio utiliza sólo piezas especificadas por el fabricante, o de las mismas características que las piezas originales. La utilización de substitutos no autorizados puede ser causa de incendios, sacudidas eléctricas, u otros peligros.
- QUE EL TÉCNICO DE SERVICIO TÉCNICO REALICE UNA COMPROBACIÓN DE SEGURIDAD**
Después de cualquier servicio o reparación de la unidad, solicite al técnico de servicio que realice una completa comprobación de seguridad tal como se describe en la literatura de servicio técnico del fabricante para asegurarse así que la unidad de vídeo se encuentra en condiciones de funcionamiento seguras.

PRECAUCIONES DE SEGURIDAD

⚠ ADVERTENCIA

PARA PREVENIR INCENDIOS O CHOQUES ELÉCTRICOS NO EXPONGA ESTE APARATO A LA LLUVIA O LA HUMEDAD.

⚠ PRECAUCIÓN

PARA PREVENIR CHOQUES ELÉCTRICOS, ASEGURASE QUE LA CLAVIJA HAGA JUEGO CON EL ENCHUFE Y CONÉCTELO COMPLETAMENTE.



Este símbolo advierte al usuario de que hay voltaje sin aislamiento dentro de la unidad de suficiente magnitud como para ocasionar sacudidas eléctricas. Por lo tanto, resultará peligroso realizar cualquier tipo de contacto con toda pieza interna de la unidad.



Este símbolo alerta al usuario de que se ha incluido importante literatura sobre el funcionamiento y mantenimiento de esta unidad. Por tanto, debe leerse atentamente tal literatura a fin de evitar cualquier problema.

Advertencia FCC: Cualquier cambio o modificación no autorizado de este equipo anulará la autorización al usuario para hacer funcionar la unidad.

FCC Warning: Any unauthorized changes or modifications to this equipment would void the user's authority to operate.

CONEXIONES/CONFIGURACION INICIAL (READY TO PLAY)

Realice la conexión de la antena o TV por cable antes de enchufar el cable de CA.

El DVD/VCR iniciará automáticamente la fijación de los canales y del reloj al enchufar el cable de CA.

CONEXIONES

Para Ant/Cable → DVD/VCR → TV

- 1 Conecte el cable de la antena al terminal IN FROM ANT del DVD/VCR.
- 2 Conecte el terminal OUT TO TV del DVD/VCR a la entrada de la antena VHF/UHF del TV con el cable RF incluido.

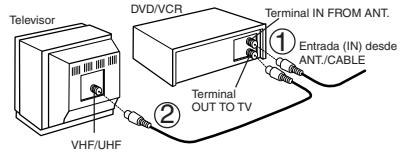

Para Sistema Digital de Satelite (DSS)/ Convertidor de cable → DVD/VCR → TV

- 1 Conecte la salida de convertidor de cable al terminal IN FROM ANT.
- 2 Conecte el terminal OUT TO TV del DVD/VCR a la entrada de la antena VHF/UHF del TV con el cable RF incluido.

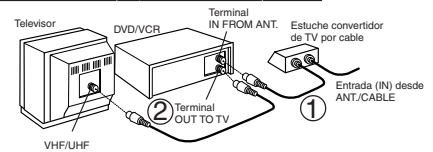

CONFIGURACION INICIAL

- 1 Encienda el TV y cambie al canal 3.
- 2 Enchufe el cable de CA. El DVD/VCR se encenderá e iniciará las fijaciones de los canales y del reloj.

- Si no aparece la pantalla de abajo, compruebe la conexión del DVD/VCR-TV y si el canal del TV está a 3, intente cambiando al canal 4.
- Para cambiar el canal de salida del DVD/VCR, consulte las instrucciones de "Canal de salida del VCR" (informaciones en inglés página 19).

Enchufe el cable de CA.

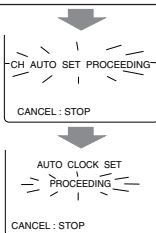

Al inicio, el idioma de la pantalla está fijado a inglés. Para cambiar el idioma, seleccione la pantalla MENU (informaciones en inglés página 18).

Si está usando un convertidor de TV por cable y en su area hay un canal de Public Broadcast Station (PBS), ajuste su convertidor al canal PBS de su area. Si está usando un receptor DSS, este debe estar apagado.

Nota

- Los botones de funciones no funcionan durante la configuración inicial.
- Para retirar un cassette durante el ajuste automático, presione EJECT en el control remoto o STOP dos veces en el aparato. En este caso, los ajustes de los canales y la hora se deben hacer manualmente. Para los ajustes seleccione la pantalla MENU (informaciones en inglés página 18).
- Dependiendo de las condiciones, el ajuste automático puede durar más de 30 minutos. En ese caso, presione STOP para detener el ajuste automático y realice los ajustes manualmente en la pantalla MENU.

⚠ PRECAUCIÓN

Al usar cables coaxiales RF del tipo "tuercas", apriételes solamente con los dedos. Un apriete excesivo puede dañar los terminales.

- 3 Las fijaciones se realizan automáticamente. Cuando termina las fijaciones, aparecerá la siguiente pantalla.

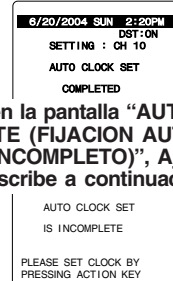

Si aparece en la pantalla "AUTO CLOCK SET IS INCOMPLETE (FIJACION AUTOMATICA DEL RELOJ ES INCOMPLETO)", Ajuste el reloj como se describe a continuación.

AJUSTE MANUAL DEL RELOJ

Si la fijación ha sido incompleta.

- 1 Presione la tecla ACTION en el control remoto para visualizar la pantalla del menú SET CLOCK.

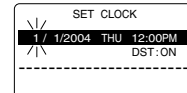

- 2 Presione ▲ ▼ para seleccionar el mes y SET para ajustar. De la misma forma, seleccione y ajuste la fecha, año, hora y DST (hora de verano).

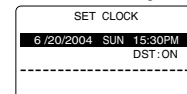

- 3 Presione dos veces la tecla ACTION para poner el RELOJ en marcha y salir.

Operaciones básicas para la reproducción

- 1 Inserte un cassette,**
 - La alimentación del DECK se activa. Si Auto VCR/TV (consulte la página 32) está en "INACT (OFF)", presione VCR/TV en el control remoto para el modo VCR.
- 2 Presione PLAY** para reproducir el cassette.
 - Si el cassette no tiene la lengüeta de prevención de grabación (página 6), se inicia la reproducción automáticamente.

Detalles especiales durante la grabación

- **Presione FF/SLOW+ o REW/SLOW-** para búsqueda de escenas hacia delante/ hacia atrás. **Presione PLAY** para liberar. Durante la búsqueda, cada vez que **presione FF o REW** se cambia la velocidad:
 - **Presione PAUSE/STILL** para imagen Fija (Congelada).
 - **Presione PLAY** para liberar.
 - **Presione PAUSE/STILL** en el modo de imagen fija para imágenes cuadro a cuadro.
 - **Presione PLAY** para liberar.
 - **Presione FF/SLOW+ o REW/SLOW-** en el modo de imagen fija para cambiar la velocidad de las imágenes a cámara lenta.
- 3 Presione STOP** para detener el cassette.

Rebobinado/Avance rápido

- **Presione REW/SLOW- o FF/SLOW+** en el modo de parada para rebobinado/avance rápido del cassette.
 - Rebobina una cinta T-120 en aproximadamente 1 minuto.
- **Presione EJECT** en el control remoto, o **STOP/EJECT** en el DECK para expulsar el cassette.

Operaciones básicas para la grabación

- 1 Inserte el cassette con lengüeta de protección de grabación** (página 6).
 - La alimentación del DECK se activa. Si Auto VCR/TV (consulte la página 32) está en "INACT (OFF)", presione VCR/TV en el control remoto para el modo VCR.
- 2 Presione CH ▲/▼, o las teclas de números** para seleccionar el canal.
- 3 Presione SPEED** para seleccionar la velocidad de grabación (página 6)
 - SP = Reproducción normal
 - SLP = Reproducción extra larga
- 4 Presione REC** para comenzar a grabar.
 - Para eliminar escenas indeseadas, presione PAUSE/STILL para hacer una pausa, y al presionar nuevamente continua la grabación.
 - No podrá ver otro canal durante la grabación.
- 5 Presione STOP** para detener la grabación.

Programación fácil para la grabación con temporizador

- 1 Presione PROG** para visualizar la pantalla de Programación.
- | P | FE | INIC | PARADA | CA | VEL |
|---|-----|------|--------|-----|-----|
| 1 | --- | --- | --- | --- | --- |
| 2 | --- | --- | --- | --- | --- |
| 3 | --- | --- | --- | --- | --- |
| 4 | --- | --- | --- | --- | --- |

ELEGIR : ▲▼ FIJAR : SET
TERMINAR : PROG

 - 1 Presion ►.**
 - 2) Para ajustar la FECHA de grabación, presione ▲▼** para seleccionar:
 - 1-31 = una vez, o DIARIO = a la misma hora de lunes a viernes, o SEMANA = a la misma hora cada semana.

Orden para elegir

Ejemplo

Fecha de hoy — 7 — 8-9.....31 — 1 — 2.....6 — DIARIO

▲/▼ Orden para elegir

SEMANTAL.....SEMANTAL SEMANTAL (SA) (LU) (DO)
- 3) Ajustes los ítems restantes,** **presione SET** para ajustar los tiempos de INICIO/PARADA, CANAL o entrada de LINEA (página 35), y la velocidad de la cinta (SP, SLP). Luego presione ▲▼ para seleccionar. **Presione PROG** para finalizar PROGRAM.

- | P | FE | INIC | PARADA | CA | VEL |
|---|-----|-------|--------|-----|-----|
| 1 | 13 | 2:00p | 3:20p | 02 | SLP |
| 2 | --- | --- | --- | --- | --- |
| 3 | --- | --- | --- | --- | --- |
| 4 | --- | --- | --- | --- | --- |

FIJACION ES COMPLETO
CANCELAR : ADD/DEL
ELEGIR : ▲▼ FIJAR : SET
TERMINAR : PROG

Presione ▲▼ para seleccionar un número que no está usando para ingresar mas programas y **presione SET** para ajustar. Luego repita el paso 2.

O **Presione nuevamente PROG** para salir.

Grabación de un toque

- **Grabación de un toque** **Presione REC** repetidamente para ajustar la hora de grabación (30 min - 4 horas).
 - La videograbadora termina la grabación a una hora programada.

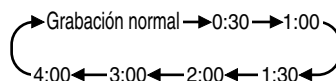

Operaciones básicas del DVD

- 1** Presione **POWER** en el control remoto o el aparato.
- 2** Presione **DVD** para seleccionar el modo DVD.
- 3**
 - 1) Presione **OPEN/CLOSE**.
 - 2) Ponga un disco en la bandeja de disco.
 - Sujete el disco sin tocar ninguna de sus superficies, póngalo con el lado donde esté impreso el título hacia arriba, alinéelo con las guías y póngalo en su posición apropiada. Disco de 3" (8 cm) / Disco de 5" (12 cm)
- 4** Presione **PLAY** para iniciar la reproducción. La bandeja del disco se cierra automáticamente.
 - Si está usando un DVD interactivo y aparece el menú de títulos (TITLE MENU), siga al paso 5.
- 5** Presione **▲▼◀▶** o las teclas numéricas para seleccionar el artículo deseado. Presione **SET** o **PLAY** para la reproducción. **Si usa las teclas numéricas, la reproducción comienza automáticamente.**
- 6** Presione **STOP** para parar la reproducción.
- 7** Presione **OPEN/CLOSE** para expulsar el disco.
 - **Para buscar una escena particular**
Búsqueda hacia adelante
 Presione **FF/SLOW+** en el modo de reproducción.
Búsqueda hacia atrás
 Presione **REW/SLOW-** en el modo de reproducción.
 (Para liberar, presione **PLAY**)
 - **Para saltar un capítulo o una pista**
Salto hacia adelante
 Presione **SKIP▶▶I** en el modo de reproducción.
Salto hacia atrás
 Presione **I◀◀ SKIP** en el modo de reproducción.
 - **Para ver una imagen fija**
 Presione **PAUSE/STILL** durante la reproducción.
 (Para liberar, presione **PLAY**)
 - **Para ver imágenes cuadro a cuadro (DVD)**
 Presione **PAUSE/STILL** en el modo de imagen fija.
 La imagen avanza un cuadro cada vez que presiona la tecla. (Para volver a la reproducción normal, presione **PLAY**)
 - **Para ver en cámara lenta (DVD)**
 Presione **FF/SLOW+** o **REW/SLOW-** en el modo de imagen fija.
 (Para liberar, presione **PLAY**)

Funcionamiento del DVD utilizando visualizaciones en pantalla

Quando se presiona **DISPLAY**, la visualización en pantalla muestra la información del disco (título / capítulo / número de lista, tiempo transcurrido de reproducción, audio / idioma del subtítulo, y ángulo) e información (repetir la reproducción, modo reproducción, Karaoke vocal encendido / apagado, etc.).

- 1** Presione **DISPLAY** en el modo reproducción o parada para visualizar las visualizaciones en pantalla.
 - Cada vez que se presione **DISPLAY**, la visualización en pantalla cambia como se muestra a continuación.
- Información seleccionada del disco
↓
Información seleccionada del DECK
↓
Pantalla normal
- 2** Presione **▲▼** (o **◀▶**) para seleccionar el ítem deseado. Presione **SET** para ajustar.
 - 3** Presione **▲▼** para seleccionar el ajuste deseado. Presione **SET** para ajustar. **Para volver a la pantalla normal, Presione repetidamente CLEAR o DISPLAY.**

<Ejemplo (Vídeo DVD)>

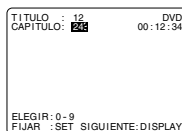
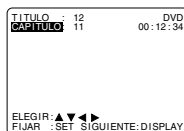

<Ejemplo (DVD-RAM)>

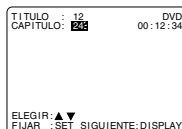
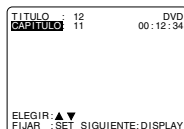



Fijaciones iniciales

- 1 Presione DVD** para seleccionar el modo DVD.
- 2 Presione ACTION en el modo de parada** para visualizar MENU.
- 3 Presione ▲▼** para seleccionar el artículo deseado.
Presione SET.
IDIOMAS DEL DISCO
Todos los idiomas ofrecidos en el disco pueden ser ajustados. Si el idioma ajustado no es ofrecido en el disco, se seleccionará el idioma original del disco.
SALIDA DE AUDIO
Puede usted ajustar la salida audio procedente del terminal de salida audio digital.
DETENER RASTREO
Para seleccionar "CAMPO", "CUADRO" o "AUTO" para prevenir inestabilidad o para permitir ver textos pequeños o patrones finos claramente en el modo de imagen fija.
TV PREFERENCIA
Para seleccionar cuando el material del vídeo es para pantalla ancha y se quiere reproducir en el estilo Pan&Scan, en el estilo Letterbox o en el estilo 16:9 en la pantalla.
- 4 Presione ▲▼** para seleccionar el artículo deseado.
Presione SET.
- 5 Volver a visualizar el menú de DVD para continuar el ajuste.**
Presione ACTION y pase al paso 3 para ajustar otro ajuste o, para salir, **presione ACTION** dos veces.

Cambio del idioma de subtítulos [Vídeo DVD solamente]

El idioma de los subtítulos seleccionado al hacer las fijaciones iniciales se puede cambiar por otro idioma diferente, si éste se encuentra disponible.

- 1**  **Presione SUBTITLE** durante la reproducción.
Cuando no haya subtítulos grabados, se visualizará "-" en lugar del número de idioma.
- 2**  **Presione SUB TITLE, ▲▼** o las teclas numéricas para seleccionar el idioma deseado.

Selección de IDIOMAS DEL DISCO [DVD solamente]

- Seleccione "AUDIO"**
(Fijación de fábrica : inglés)
Inglés / Español / Francés / Japonés :
Original : Se seleccionará el idioma original de cada disco.
OTRO 0000 : Se puede seleccionar el otro idioma.
- Seleccione "SUBTITULO"**
AUTO : Se seleccionará el mismo que fue seleccionado en la preparación de "AUDIO". (Fijación de fábrica)
- Si el idioma seleccionado en la preparación de "AUDIO" se utiliza durante la reproducción, los subtítulos no aparecerán.
 - Si se utiliza otro idioma durante la reproducción, los subtítulos aparecerán en el idioma seleccionado en la preparación de "AUDIO"
- Inglés / Español / Francés / Japonés :**
OTRO 0000 : Se puede seleccionar el otro idioma.
- Seleccione "MENU"**
(Fijación de fábrica : inglés)
Inglés / Español / Francés / Japonés :
OTRO 0000 : Se puede seleccionar el otro idioma.

Visión desde otro ángulo [DVD solamente]

Algunos discos DVD tienen escenas que han sido filmadas simultáneamente desde ángulos diferentes.

Con estos discos, la misma escena podrá verse desde cada uno de estos ángulos diferentes utilizando el botón ANGLE.

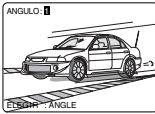
- 1**  **Presione ANGLE** durante la reproducción para visualizar la selección del ángulo.
- 2**  **Presione ANGLE** repetidamente o ▲▼ para seleccionar el ángulo deseado.

Spanish Quick Use Guide/ Guía para rápida consulta

Selección de vocal para los discos de Karaoke [DVD solamente]

1 Presione **AUDIO** durante la reproducción para visualizar la pantalla AUDIO.

2  Presione ◀▶ para seleccionar VOZ y presione AUDIO o ▲▼ para seleccionar tal como se indica a continuación.

- DVD Karaoke (1 vocal) VOZ ACTIVO → VOZ INACTIVO
- DVD Karaoke (2 vocals) VOZ V1 → VOZ V2 → VOZ V1+V2 → VOZ INACTIVO

Cambio del idioma de la pista de sonido [DVD solamente]

El idioma de la pista de sonido seleccionado al hacer las fijaciones iniciales se puede cambiar por otro idioma diferente, si éste se encuentra disponible.

1  Presione **AUDIO** durante la reproducción para visualizar SONIDO en la pantalla.

2  Presione **AUDIO**, ▲▼ o las teclas numéricas para seleccionar el idioma deseado.

Utilización de un menú de títulos [DVD solamente]

Algunos discos con películas, vienen con dos o más títulos. Por ejemplo, si el disco tiene un menú de títulos grabados, el botón TITLE podrá utilizarse para seleccionar el título de la película.

1 Presione **TITLE** durante la reproducción. Ahora se visualiza una lista de los títulos del disco.

2  Presione ▲▼◀▶ o las teclas de números para seleccionar el título deseado. Presione SET o PLAY para elegir.

<ejemplo>

Utilización de un menú de DVD [DVD solamente]

Algunos discos DVD ofrecen un menú especial. Este menú incluye guías para contenidos únicos, audio, subtítulos, idiomas, etc.

Aunque los contenidos y las operaciones se cambian, los siguientes son unos pasos básicos para el uso del menú.

1 Presione **MENU** durante la reproducción. El menú de DVD introducido en el disco se visualiza ahora.

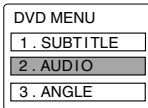
2  Presione ▲▼◀▶ o las teclas de números para seleccionar el ítem deseado. Presione SET o PLAY para elegir.

<ejemplo>

Ampliación de la imagen [DVD solamente]

Durante la reproducción de un DVD, puede ampliar partes específicas de una imagen y seleccionar la relación de zoom usando el botón ZOOM.

Presione **ZOOM** repetidamente para cambiar el tamaño de la imagen como se indica a continuación:

- Use los botones ▲, ▼, ◀ y ▶ para desplazar la posición hacia arriba, hacia abajo, hacia la izquierda o hacia la derecha.

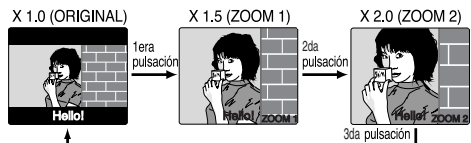

Funcionamiento de la ejecución de MP3/JPEG

Puede utilizar esta unidad para reproducir audio de formato MP3/JPEG, grabado para uso personal con una computadora, etc., en un CD-ROM o CD-RW. La ejecución no podrá realizarse en algunos casos, debido a las condiciones de la grabación.

- 1 Presione **POWER** en el control remoto o DECK.
- 2 Presione **OPEN/CLOSE** y a continuación coloque un disco MP3/JPEG en la bandeja de discos. Presione **OPEN/CLOSE** para cerrarla.
- 3 Se visualizará el MENU MP3/JPEG y la ejecución se iniciará automáticamente. (Se visualizará el directorio del CD.)

- 4 ■ **Ejecución MP3/JPEG** (Durante el modo STOP)
 - Presione **▲▼** para seleccionar un archivo MP3 (🎵) o un archivo JPEG (🖼️), y presione **SET** o **PLAY**.
 - **MP3**
 - Búsqueda hacia adelante/hacia atrás ⇒ Presione **FF/SLOW+** o **REW/SLOW-** durante la ejecución.
 - Salto de pista hacia adelante/hacia atrás ⇒ Presione **SKIP+ ▶▶|** o **SKIP- |◀◀** durante la ejecución.
 - **JPEG**
 - Búsqueda siguiente/anterior ⇒ Presione **SKIP+ ▶▶|** o **SKIP- |◀◀**.
 - Inicie la muestra-diapositiva ⇒ Presione **FF/SLOW+** o **REW/SLOW-**.
 - Ampliar una imagen ⇒ Presione **ZOOM**.
 - Girar una imagen ⇒ Presione **ANGLE**.
 - Presione **STOP** para detener la operación descrita arriba.

- **Selección MODO DE REPRODUCCION** (Durante el modo STOP)
 - Presione **▲▼** para seleccionar el MODO DE REPRODUCCIÓN deseado. **[MODO DE REPRODUCCIÓN]**
 - NORMAL:** Todos los archivos se reproducen sólo una vez.
 - REPETICION DE UNA MUSIC:** El archivo seleccionado se reproduce repetidamente.
 - REPETICION DE UN ARCHIVO:** Los archivos que se encuentran en la carpeta seleccionada se reproducen repetidamente.
 - REPETICION DEL DISCO:** Todos los archivos se reproducen repetidamente.

Estado de la función

Area de las carpetas
(La carpeta visualizada actualmente se volverá verde)

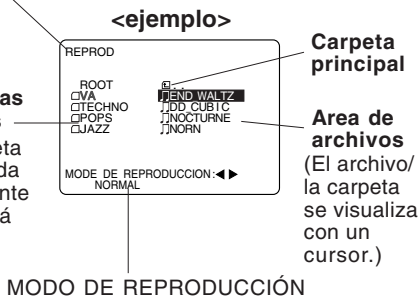

Carpeta principal

Area de archivos
(El archivo/la carpeta se visualiza con un cursor.)

🎵: Archivo MP3	🖼️: Archivo JPEG
📁: Carpeta	📁: Carpeta principal

- 5 Presione **ACTION** para regresar al DVD MENU PRINCIPAL.

Index

DECK & VCR

- A** ACTION button 8, 18
 - Accessories 4
 - ADD/DELETE button
 - (Add or Delete a Channel) 8, 19
 - Audio Broadcast types
 - (Stereo/SAP/Mono) 26
 - Audio Mode (Playback, Recording) 27
 - Auto Operation Functions 31
 - Auto Shut-Off 33
- B** Batteries 4
- Built-in Head Cleaner 6
- C** Channel ("SET UP CHANNEL") 18
 - Channel Up/Down,
 - Tracking/V-Lock Button 4, 8
 - Clock ("SET CLOCK") 18
 - CM/ZERO SEARCH button 8, 30
 - Commercial Skip 30
 - Connections 12 ~ 15
 - Copy Your Tapes (Dubbing) 35
 - COUNTER RESET button 8, 30
 - Customer Services Directory 61
- D** DISPLAY button 8, 11
 - DST (Daylight Saving Time) 19
- E** EJECT button 8, 20
 - ENTER button
 - (For tuning TV Channel) 8, 28
- F** FAST FORWARD/SLOW+ button 8, 20
- H** Head Cleaning 4
- I** Index Search 30
 - Indicator (Multi Function Display) 11
 - Initial Setup (Ready to Play) 16, 17
 - INPUT button 8, 35
- L** Limited Warranty 60, 61
 - Location of Controls
 - (Remote, DECK) 8 ~ 10
- M** Multi-Brand Control 28, 29
 - Multi Function Display (Front Display)
 - ON/OFF Feature 34
- O** On-Screen Displays (VCR) 11
 - One Touch Recording 21
- P** PLAY button (Playback a Tape) 8, 20
 - POWER button 8
 - PROG button (PROGRAM) 8, 24
 - Program Clear, Review, Replace 25
- Q** Quality Picture 4
- R** REC button (Record on a Tape) 8, 21
 - Record Tab 6
 - Remote Sensor 9
 - Remote Warning 34
 - Repeat Play 31
 - Reset All Memory Functions 9
- REWIND/SLOW- button 8, 20
- S** SAP/Hi-Fi 27
 - SEARCH button 8, 30
 - Spanish Quick Use Guide 62 ~ 69
 - Specifications 7
 - SPEED button 8, 21
 - Still (Freeze) Picture 20
 - STILL/PAUSE button (Still Picture) .. 8, 20
 - STOP button 8, 20
- T** Tape Position, Tape Status 31
 - Tape Select 31
 - Timer Recording 24
 - Trouble Shooting 58, 59
 - TV mode button 8, 28
- V** VCR Lock 32
 - VCR mode button 8, 28
 - VCR/TV button 8, 21
 - VCR/TV Selection Feature 32
 - VOLUME +/- button (TV Volume) 8, 28
- W** Warning and Instruction Displays 57
 - Weak Signal Display 33

DVD

- A** ACTION button 8, 52
- ANGLE button
(Multiple Angle Viewing) 8, 37, 51
- AUDIO button
(Audio Soundtrack Language) 8, 36
- Audio Output
(For Selecting Audio Output) 53
- Auto-Power Off Function 23
- C** CLEAR button 8, 39
- Component Video Output 10, 13
- D** Direct Navigator 42
- Disc Languages 52
- DISPLAY button
(“On-Screen Display”) 8, 44
- DTS 14
- DVD Menu 38
- DVD mode button 8, 28
- DVD-RAM (DVD-VR) 42
- F** Frame by Frame Picture 23
- Forward/Reverse Chapter/Track Skip... 23
- Forward/Reverse Scene Search 23
- J** JPEG 49 ~ 51
- K** Karaoke
(Vocal Selection for Karaoke Discs) ... 37
- L** Language Code List 56
- M** MENU button
(To display DVD Menu) 8, 38
- MP3 49
- Multiple Angle Viewing 37
- O** OPEN/CLOSE button 8, 22
- Optical Digital Audio Output 10, 15
- P** PLAY button (Play a Disc) 8, 22
- Play List 43
- Program Play (For CD) 39
- Progressive Scan 10, 13, 55
- R** Random Play (For CD) 40
- Repeat Play 47, 48
- Resume Function 23
- RETURN button 8, 22
- Rotation 51
- S** SKIP+ ►►I or SKIP- I◄◄ button
(Forward/Reverse Chapter/Track) 8, 23
- Slide-show 50
- SLOW+/SLOW- button
(Slow Motion Picture) 8, 23
- STILL/PAUSE button
(Still Picture or Pause) 8, 23
- Still Mode
(For selecting “FIELD” or “FRAME”) .. 54
- STOP button 8, 22
- SUB TITLE button
(For selecting Subtitle Language) ... 8, 36
- S-Video Out 10, 13
- T** TITLE button (Title Menu) 8, 38
- TV Mode
(For selecting the screen display style) .. 54
- V** VOLUME ADJUST button 8, 41
- V.S.S. (Virtual Surround Sound) 8, 23
- Z** ZOOM button (Picture Zoom) 8, 37, 51

LSQT0796 A

**Panasonic Consumer Electronics Company,
Division of Matsushita Electric Corporation of America**

One Panasonic Way Secaucus, New Jersey 07094

Panasonic Sales Company ("PSC"),

Division of Matsushita Electric of Puerto Rico, Inc.

Ave. 65 de Infantería. Km. 9.5 San Gabriel Industrial Park, Carolina,
Puerto Rico 00985



Printed in Indonesia
LSQT0796 A
S1203-2024